

CLIENT MANUAL



CONTENTS

Welcome	03
About Coex	04
Coex Infrastructure	06
Events at Coex	10
World Trade Center Coex MICE Cluster	11
Coex Green Initiatives	12
Room Reservations and Contract Signing	13
Services Provided by Coex	15
Services Provided by Coex's Designated Service Providers	16
Responsibilities of the Event Host	17
Important Contact Points	17
Convenient Facilities	18
Emergency Exit Locations	19
Coex Equipment Rental Rates	21
Coex Service Partner List	22
Coex Facility Map	23
Facility Chart	35

Contact Details

Coex, 513, Yeongdong-daero, Gangnam-gu, Seoul 06164, Korea
Telephone: +82 2 6000 1122, 1123
Facsimile: +82 2 6944 8374
Email: sales@coex.co.kr
Website: www.coexcenter.com

Memberships

Coex is a member of the following professional organizations:

International

AFECA (Asian federation of Exhibition & Convention Associations)
AIPC (International Convention Center Association)
ICCA (International Congress & Convention Association)
UFI (Union des Foires Internationales)
WTCA (World Trade Center Association)

Domestic

AKEI (Association of Korean Exhibition Industries)
KAPCO (Korea Association of PCO)
KMA (Korea MICE Association)
KEOA (Korea Exhibition Organizers Association)
KITA (Korea International Trade Association)
SMA (Seoul MICE Alliance)
Association of Korea Exhibition Center

Welcome

Thank you for choosing the Coex Center as the venue for your event. We are excited to be working with you to create a memorable and successful experience for your guests.

The Coex Center prides itself on providing a superior level of service to event hosts and attendees. Our thirty years of experience as Korea's leading exhibition and convention center, combined with our valuable domestic and global network and extensive facilities, ensures an event environment that is professional, uncomplicated, and secure.

Our flexible meeting rooms, nearby hotels and transportation infrastructure, and numerous amenities, represents true convergence of business and leisure. We are confident that you will find everything you need here on-site to meet the needs of your event.

This Client Manual will help you get to know our center, while offering information on our services and the event planning process at Coex.

For any further questions, or for further information about Coex, contact us by email. Our highly-qualified team is ready to assist and support you in any way that we can.

We look forward to welcoming you to Coex!

Coex

ABOUT Coex

Coex, a future-focused leader of the MICE industry

The Coex Convention & Exhibition Center in Seoul is Korea's premier events venue, providing more than 30 years of experience in the domestic and international MICE industry. Coex is conveniently located in the heart of Seoul's business district with 5-star hotels, a mega-shopping mall, convenient transportation linkage, and an advanced IT infrastructure to ensure that all your needs are met right here under one roof.

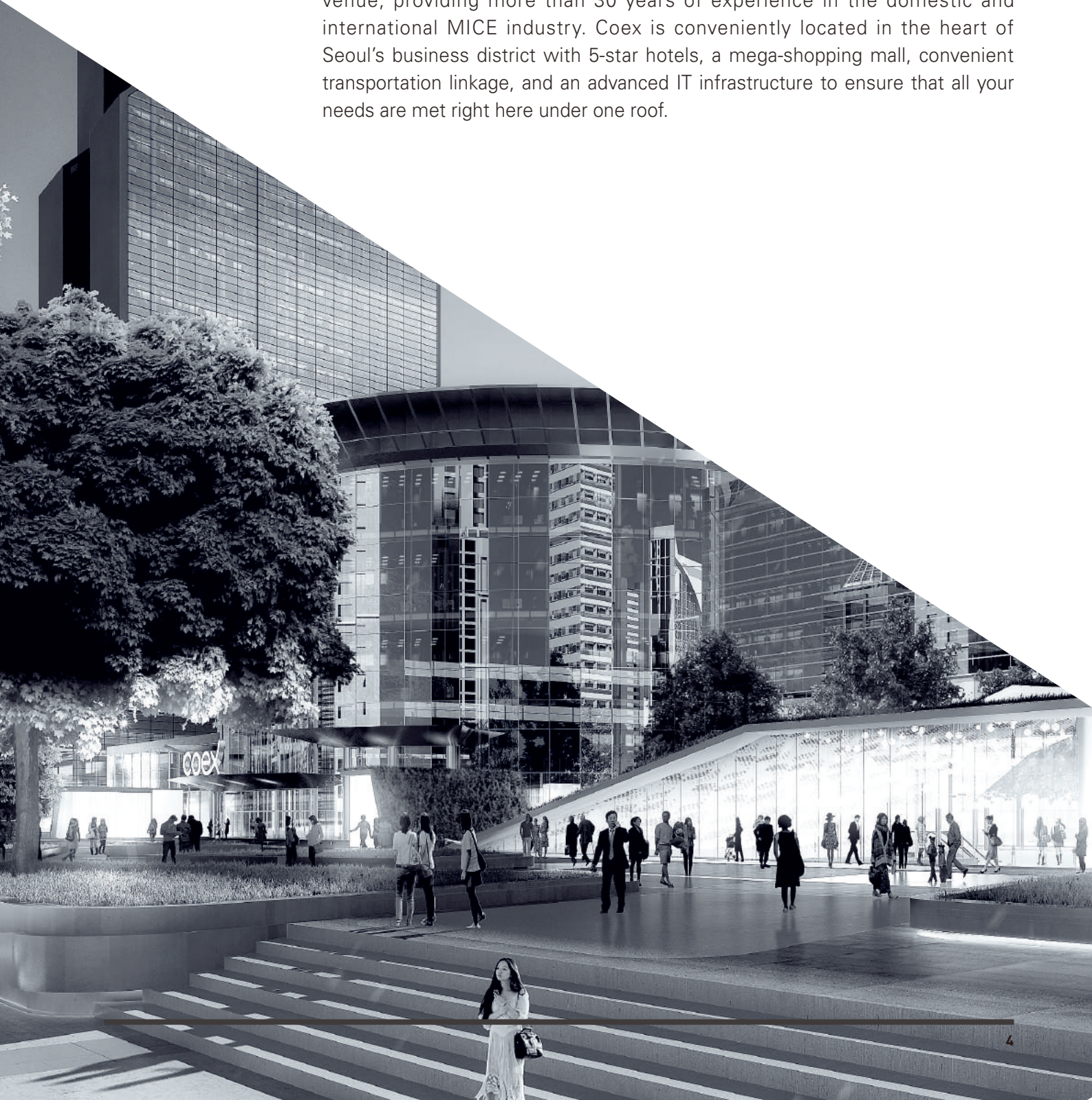

Facilities

Meeting Rooms & Exhibition Halls	4 exhibition halls (36,007m ²) & 51 meeting rooms
Attached Hotels	Grand Intercontinental Seoul Parnas (516 rooms) Intercontinental Seoul Coex (656 rooms) Oakwood Premier Coex Center (280 rooms)
Transportation	City Airport Terminal Subway Line No. 2, 9
Entertainment	Seven Luck Casino SMTown@Coex Artium & Art Hall Coex Aquarium MEGABOX (Multiplex, 16 screens)
Shopping	Lotte Duty-Free Hyundai Department Store & Duty-Free Starfield Coex Mall Parnas Mall



Coex INFRASTRUCTURE

001 | TRANSPORTATION

Incheon International Airport has been named the world's best airport for twelve years running, and it's only an hour bus ride away from Coex. Airport limousine buses run directly from the Coex CALT City Airport Terminal every ten minutes, and guests are able to check-in their bags on-site.

From Incheon International Airport

Seoulbus Limousine Bus (No.6006)

Travel Time	Approximately 65-80 minutes (70km)
Single Fare	15,000 KRW (Adult) / 11,000 KRW (Child, 6-12years)
Airport Bus Stop	Incheon International Airport (Terminal1: 4A,4B), (Terminal2: 14-16,B1)
Where to Buy Tickets	Seoulbus Limousine Bus Stop
Telephone	+82 2 577 1343~5

CALT Limousine Bus (City Airport, Logis & Travel, Korea, No.6103)

Travel Time	Approximately 65-80 minutes (70km)
Single Fare	15,000 KRW (Adult)/ 10,000 KRW (Child, 6-12 years)
Airport Bus Stop	Incheon International Airport (Terminal1: 7A), (Terminal2: 21-22,B1)
Where to Buy Tickets	CALT Limousine Bus Stop
Telephone	+82 2 551 0077~8

KAL Limousine Bus (No.6703)

Travel Time	Approximately 65-80 minutes (70km)
Single Fare	16,000 KRW (Adult)/ 10,000 KRW (Child, 6-12 years)
Airport Bus Stop	Incheon International Airport (Terminal1: 3B,4A), (Terminal2: 17~19,B1)
Where to Buy Tickets	Incheon International Airport KAL Limousine Counter No.22(Terminal1), KAL Limousine Bus Stops(Terminal2)
Telephone	+82 2 551 0077,8

Via Taxi

Time to destination	Approximately 60 minutes
Single fare	Regular Taxi 60,000 KRW (approximate fare) Luxury Taxi 90,000 KRW (approximate fare)

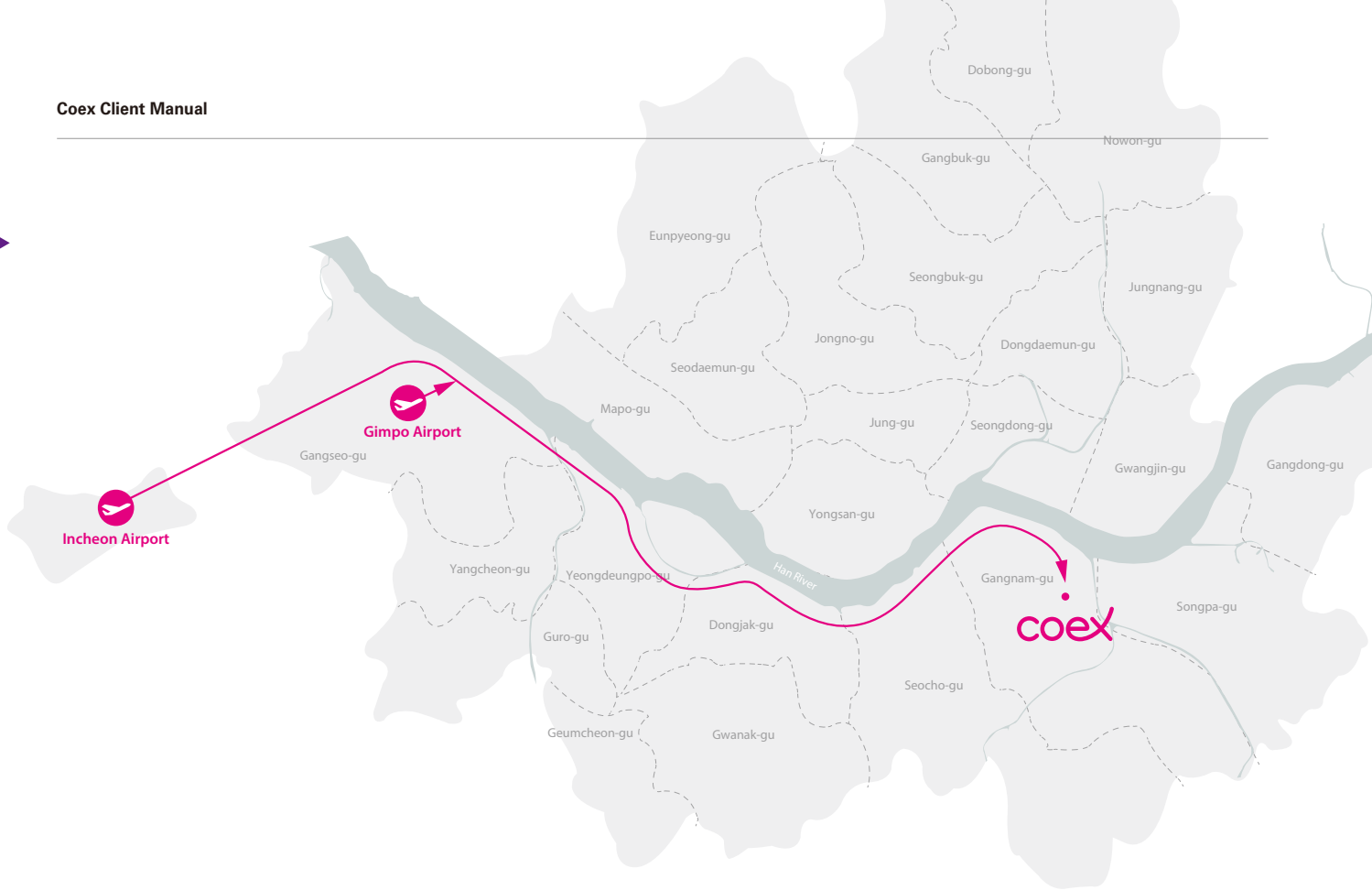

From Gimpo Airport

Airport Limousine Bus (No.6000)

Travel Time	Approximately 60 minutes (30km)
Single Fare	7,000 KRW (Adult)
Airport Bus Stop	Gimpo Airport (1F)
Where to Buy Tickets	Airport Limousine Bus Stops
Telephone	+82 2 2664 9898

Via Taxi

Time to destination	Approximately 50 minutes
Single fare	Regular Taxi 30,000 KRW (approximate fare) Luxury Taxi 50,000 KRW (approximate fare)

By Subway

Coming from Samseong Station (Line No.2)

From Samseong subway station, use exit five or six which connects directly to Starfield Coex Mall. Follow the signs for the Coex exhibition halls which will lead to you to the first floor of the center.

Coming from Bongeunsa Station (Line No.9)

From Bongeunsa subway station, use exit seven which connect directly to Starfield Coex Mall. Follow the signs for the Coex exhibition halls which will lead to you to the first floor of the center.

002 | HOTELS NEAR THE COEX CENTER

★★★★★

01	Grand Intercontinental Seoul Parnas	521, Teheran-ro, Gangnam-gu	www.grandicparnas.com	+82 2 559 7777
02	Intercontinental Seoul Coex	524, Bongeunsa-ro, Gangnam-gu	www.iccoex.com	+82 2 3452 2500
03	Oakwood Premier Coex Center	46, Teheran-ro 87-gil, Gangnam-gu	www.oakwoodpremier.co.kr	+82 2 3466 7000
04	Le Méridien Seoul	120 Bongeunsa-ro, Gangnam-gu	www.lemeridienseoul.com	+82 2 3451 8000
05	Park Hyatt Seoul	606, Teheran-ro, Gangnam-gu	seoul.park.hyatt.com	+82 2 2016 1234
06	Lotte Hotel World	240, Olympic-ro, Songpa-gu	www.lottehotel.com/world	+82 2 419 7000
07	JW Marriott Seoul	176, Sinbanpo-ro, Seocho-gu	www.jw-marriott.co.kr	+82 2 6282 6262
08	Sheraton Seoul Palace Gangnam Hotel	160, Sapyeong-daero, Seocho-gu	www.sheratonseoulpalace.com	+82 2 532 5000
09	Signiel Seoul	300, Olympic-ro, Sonpa-gu	www.lottehotel.com/signielseoul	+82 2 3213 1000

★★★★

10	Imperial Palace Seoul	640, Eonju-ro, Gangnam-gu	www.imperialpalace.co.kr	+82 2 3440 8000
11	Glad Live Gangnam	223, Bongeunsa-ro, Gangnam-gu	www.gladlive-hotels.com	+82 2 6177 5000
12	Hotel Prima	536, Dosan-daero, Gangnam-gu	www.prima.co.kr	+82 2 6006 9114
13	Hotel Riviera	737, Yeongdong-daero, Gangnam-gu	www.hotelriviera.co.kr	+82 2 541 3111
14	Hotel Foreheal	117, Hakdong-ro, Gangnam-gu	www.foreheal.com	+82 2 511 8810
15	L7 Gangnam	415, Teheran-ro, Gangnam-gu	www.lottehotel.com/l7/gangnam	+82 2 2011 1007
16	Four Points by Sheraton Gangnam	203, Dosan-daero, Gangnam-gu	www.fourpointsseoulgangnam.co.kr	+82 2 2160 8900
17	Hotel Peyto Samseong	9, Teheran-ro 87-gil, Gangnam-gu	www.peytohotel.com	+82 2 6202 2000
18	Ramada Seoul	410, Bongeunsa-ro, Gangnam-gu	www.ramadaseoul.co.kr	+82 2 6936 8100
19	HOTEL in 9	618, Youngdong-Daero, Gangnam-gu	www.hotelin9.com	+82 2 311 9000

★★★

20	Hotel Entra	508, Dosan-daero, Gangnam-gu	www.entrahotel.com	+82 2 500 1500
21	IBIS Styles Ambassador Gangnam	431, Samseong-ro, Gangnam-gu	ibisstyles.ambatelen.com/gangnam	+82 2 3454 1101
22	Hotel Sunshine	205, Dosan-daero, Gangnam-gu	www.hotelsunshine.co.kr	+82 2 548 8222
23	Coatel	11, Gangnam-daero 53-gil, Seocho-gu	www.coatel.co.kr	+82 2 6288 3333
24	Urban Place Gangnam	30, Hyoryeong-ro 77-gil, Seocho-gu	www.urbanplaces.co.kr	+82 2 3474 3399
25	Hotel Denim	66, Nonhyeon-ro, Gangnam-gu	hoteldenim.com	+82 2 2058 1000
26	Hotel URI&	96, Samseong-ro, Gangnam-gu	www.uri-nhotel.com	+82 2 500 2300

Residences

27	Hotel ArtnouveauSeocho	357, Seocho-daero, Seocho-gu	www.artnouveauseocho.com	+82 02 560 7101~3
28	Gangnam Artnouveau City Hotel	49, 74 gil, Seocho-daero, Seocho-gu	www.gnanhotel.com	+82 2 580 750
29	ETIS Residence	13, Teheran-ro 92-gil, Gangnam-gu	N/A	+82 2 539 9080
30	Blooming Serviced Residence Hotel	3-4, 28gil, Tehaeran-ro, Gangnam-gu	www.bloominghouse.co.kr	+82 070 7204 2500

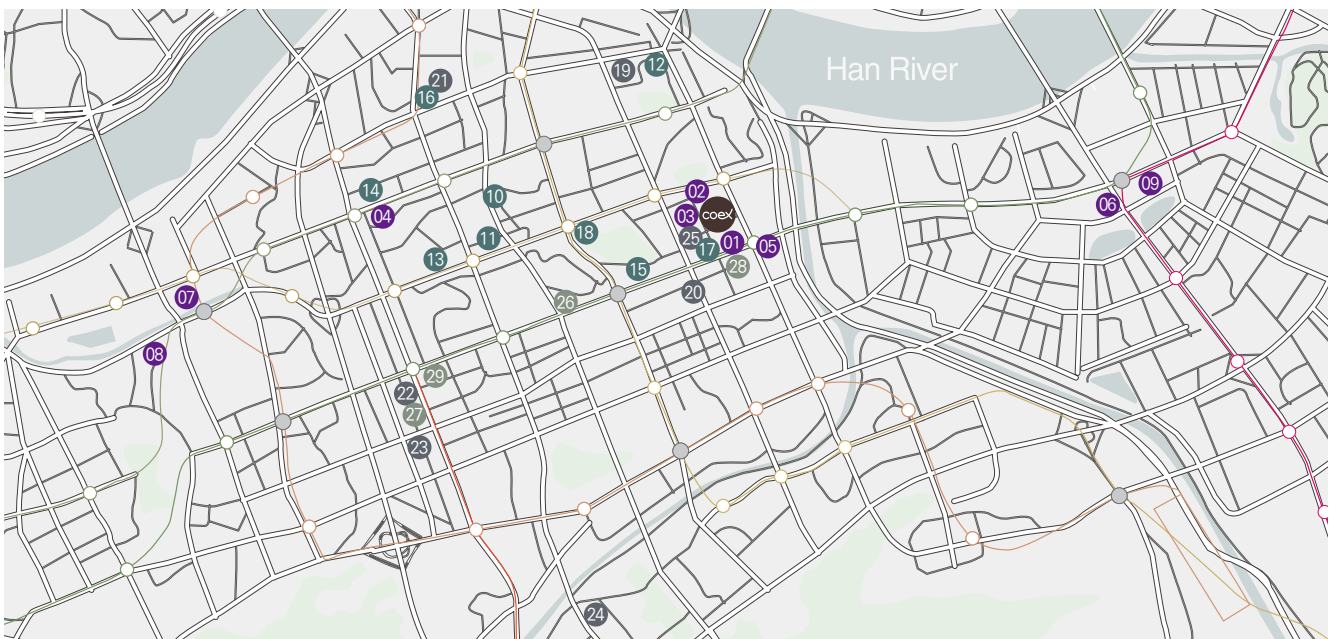

003 | SHOPPING

Starfield Coex Mall is the largest of its kind in Asia, with over 165,000 square meters of shops, restaurants, cafes, and entertainment connecting directly to the Coex Center. Starfield Coex Mall attracts over 300,000 visitors every weekend, and is a convenient dining and shopping destination for event guests.

Starfield Coex Mall
Hyundai Department Store & Duty Free
Lotte Duty Free
Parnas Mall



004 | ENTERTAINMENT

SMTown@Coex Artium and SM Town

A musical theater with 808 seats, Coex Artium shows star-studded Korean musicals as well as international performances featuring original casts from overseas.

In 2014, one of Korea's top music agencies, SM Entertainment, launched the very first 'SM Town' within the CoexArtium theater building. SM Town offers K-Pop fans from around the world an exclusive peek into the lives of famous Korean music artists and celebrities.

Seven Luck Casino

Seven Luck is a 3-story casino equipped with more than 200 table games and machines. The casino is open exclusively to international visitors, and offers 5 VIP rooms with luxury service and privacy.



EVENTS AT Coex

Coex's state-of-the-art infrastructure and spacious conference rooms and exhibition halls attract many high-profile, large-scale events to the center. In 2010, Coex hosted the world's 20 most powerful leaders during the G20 Seoul Summit. Renowned for its expertise, Coex again successfully hosted the leaders of 53 countries during the Seoul Nuclear Security Summit in 2012.

Coex's strategic location in Seoul is one of many benefits for event organizers and participants. The city's excellent infrastructure and convenience and continued developments offers something for everyone. Seoul became a UNESCO City of Design in 2010 and, was recently listed in the New York Times' list of "Must -See Destinations" and Lonely Planet's "Best in Travel : Top 10 Cities:"

Hosted Events by Coex

- 2000 ASEM (Asia-Europe Summit, 7,000 pax)
- 2002 World Cup Media Center
- 2007 World Lung Cancer Congress (5,500 pax)
- 2010 G20 Seoul Summit (15,000 pax)
- 2011 World Congress on Dermatology (12,000 pax)
- 2012 Seoul Nuclear Security Summit (10,000 pax)
- 2013 UFI Congress(1,000 pax)
- 2014 Air Cargo Forum(5,000 pax)
- 2015 World Allergy Congress (4,000 pax)
- 2016 94th General Session & Exhibition of the International Association of Dental Research (12,000 pax)
- 2017 UIA World Congress of Architects and General Assembly (6,000 pax)
- 2018 Congress of the International Fiscal Association (3,000 pax)
- 2019 International Bar Association Annual Conference (6,000 pax)

Secured Events by Coex

- 2020 International Congress of the International Radiation Protection Association (4,000 pax)
- 2021 The meeting of the World Federation of Neuro-Oncology Society (2,000 pax)
- 2022 Asian-Australasian Congress of Anaesthesiologists (3,000 pax)

With cutting-edge facilities, proven experience, and unique cultural resource, Coex promises to fully support the success of your event.

WORLD TRADE CENTER Coex MICE CLUSTER

The World Trade Center Coex MICE Cluster, which officially launched in 2015, promotes increased collaboration between 16 of the World Trade Center site's leading business travel and events facilities in order to offer optimal services to domestic and global business travelers. All-in-one cooperative marketing and management strategies enhance the World Trade Center's entertainment, shopping, business, transportation, and accommodation services, while travel packages and facilities for guests improve the Coex experience. A new MICE lounge and information office, tax exemption opportunities, Starfield Coex Mall, collaborative grand sales, accommodation options and more, help make the WTC Coex MICE Cluster an unrivaled destination for business guests.

- | Korea International Trade Association
- | WTC Seoul
- | Seven Luck Casino
- | Starfield Coex Mall
- | Megabox Theatre
- | Coex Aquarium
- | SHINSEGAE FOOD
- | SM Entertainment
- | Intercontinental Hotel
- | CALT City Airport Terminal
- | Hyundai Department Store
- | Hanmoo Convention
- | Lotte Duty Free
- | Coex Co., Ltd.



Coex GREEN INITIATIVES



Leed Certificate

Coex was the first convention center in Asia to receive the silver LEED (Leadership in Energy and Environmental Design) certificate from the U.S. Green Building Council. Although difficult to obtain for existing facilities, this certification highlights Coex's sincere efforts to become a greener venue.



EarthCheck Certificate

Coex acquired the EarthCheck Silver status just one year after receiving the Bronze status. EarthCheck is the global green certificate for culture, tourism and convention centers, organized by EC3 Global, Australia.

BeMS & BAS

<Using Green IT to Manage Energy at Coex>

Sustainable management of the World Trade Center is spearheaded by BeMS, our self-developed Building Energy Management System. BeMS was the first of its kind in Korea and combines environmental stewardship with advanced information technology to help make Coex a greener place. Along with BeMS, our Building Automation System, BAS, ensures safe and environmentally responsible operation of the World Trade Center Seoul.

Green Renovations

<Pursuing the Improvement of Our Environment>

- 1. Building Efficiency**
Coex is dedicated to improvement the energy efficiency of its buildings through methods such as LED lighting replacement and alternative energy research and implementation.
- 2. Water Recycling**
Coex's on-site water recycling plant helps the center use water more efficiently while preventing environmental contamination. Water recycling at Coex reduces the center's carbon emissions by 83 tons per year.
- 3. High-Tech Bike Stations**
High-tech bicycle lockers are located at various locations around the Coex premises. Each bike locker holds up to 120 bikes securely, while also protecting them from environmental and other damages.
- 4. Rooftop Green Spaces**
Green spaces planted around Coex are enjoyed by visitors as spaces for rest, as well as working to reduce the urban heat-island phenomenon.
- 5. Alternative Energy**
Coex hosts many testbed projects for alternative energy. Coex is currently testing solar lamp posts, solar roof panels, wind generators, hydrogen fuel cell batteries, and more.
- 6. Eco-Friendly Restrooms**
To make restrooms more environmentally-friendly, Coex has supplied them with biodegradable, quick-dissolving toilet paper and energy-saving hand driers.

Green MICE

<Green Meetings for Global Competitiveness>

Coex Center is moving forward with its goal to become a leader in green Meetings, Incentives, Conventions, and Exhibitions. Coex is EarthCheck-benchmarked and has a certificate in Leadership and Environmental Design. We also have a comprehensive menu of sustainability options for event planning clients, including a 'green initiative clause' in all our contracts.

3R (Reduce + Reuse + Recycle)

<Making Waste a Resource>

Coex is on a carbon diet. Our 3R waste program aims to cut our carbon footprint through reduction, reuse, and recycling of the waste produced at our center every day. Through our carbon diet, we hope to turn a higher percentage of what would be waste, back into recycled resources.

ROOM RESERVATIONS AND CONTRACT SIGNING

Coex Meeting Room Rental Hours

All Coex meeting rooms may be rented in the following time blocks

A. Morning	09:00 ~ 12:00
B. Afternoon	13:00 ~ 18:00
C. Evening	19:00 ~ 22:00
D. All-Day	09:00 ~ 18:00

Coex provides Lessees with 30 minutes of complimentary room use for both event move-in and out. If either the move-in or out exceeds the allotted complimentary 30minutes then a surcharge shall be added to the base rental fee.

Please note that utilities usage, such as electricity and heating, are included in the cost of room rental but must be paid separately for exhibition halls(see 'Management Fees'.)

Payment of Room Rental Fees

Room rental fees must be paid according to the following table

10% of rental fee	40% of rental fee	Remaining 50% of total rental fee, VAT (10%) & equipment fee
Upon signing of rental agreement	3 months prior to 1st day of rental	7 days prior to 1st day of rental

Changes to Agreed Rental Period

Subject to room availability, the Lessee may request a date change to another period within the same calendar year. In the case that the dates of the event are changed, a penalty of 10% of the total rental cost will be applied.

Cancellation of Room Rental

Penalties for the cancellation of meeting space after the signing of the rental contract are as follows

- Up to three months prior to the event : 10% of the total rental fee
- From three months to one week prior to the event : 50% of the total rental fee
- Within one week prior to the event : 100% of the total rental fee.

Any and all rental fees paid prior to the cancellation of the rental contract are non-refundable.



Partial Cancellation of Room Rental

Penalties for the cancellation of meeting space after the signing of the rental contract are as follows :

- Up to three months prior to the event: 10% of cancelled room rental fee.
- From three months to one week prior to the event: 50% of cancelled room rental fee.
- Within one week prior to the event: 100% of cancelled room rental fee.

Improper Use of Meeting Room

If the room is used outside of its intended purpose (eg: meeting room used as an exhibition space including equipment installation), an additional fee 1.5 times the room rate will be levied.

Management Fee Deposit

The Management Fee Deposit only applies to the exhibition halls (Halls A, B, C, D)

Utilities are not included in the cost of room rental, and instead are payable in the form of a Management Fee Deposit. The Management Fee includes electricity, heating, air-conditioning, water supply and drainage, compressed air etc.

The initial Management Fee Deposit is calculated at 20% of the total cost room rental before any discount premiums are applied, and must be paid no later than seven (7) days before the commencing date of lease.

Following the lease period, if the Management Fee Deposit amount is insufficient to cover the actual utility and management expenses, an additional payment may be requested. Any additional payments must be paid within 15 days of receipt. If the Management Fee Deposit amount exceeds the actual management fee to be paid, it may be used to cover other outstanding applicable charges. In the event that there are no outstanding payments to be made, the excess Management Fee Deposit shall be refunded to the Lessee.

Rental of Lobby Areas

The use of the lobby area immediately outside the rented meeting room for registration desks, and use of the allocated lobby spaces used by our official caterer, are included in the rental agreements. Additional use of extended lobby areas can be arranged on a cost per square meter basis of 10,000won/sqm 10% VAT Excluded. The woodworking equipment costs 20,000won. (VAT Excluded)

SERVICES PROVIDED BY Coex

Electricity

All standard meeting rooms rental includes electricity usage up to 3KW. Electricity usage beyond the basic amount as well as any special requests, such as additional outlets, requires the hiring of a designated contractor and will incur an additional fee.

Equipment Rental

All standard meeting rooms for 50 or more pax includes one complimentary podium (equipped with a wired microphone) and one complimentary lobby registration table with two chairs. Most rooms with a capacity above 150 pax include built-in projection screens. Some of our larger meeting rooms also have podium areas, and built-in simultaneous translation booths. Should you require additional equipment for your event, please refer to page 21 for the full equipment list and rental rates.

Furniture and Furniture Arrangement

Rates include your preferred setup in theatre, classroom or banquet style up to the maximum capacity of the room. If you wish to have the room re-arranged during a single day event, (such as from classroom to banquet style) there is an additional labor charge.

Waste Removal and Disposal

Meeting room rental rates include waste removal. For exhibition-style setups, however, there is an additional fee based on the amount of waste produced. Our waste management teams sorts through the waste for recyclables.

Parking Tickets

Depending on the size of the room, we provide one complimentary daily parking pass for meeting organizers. Should you wish to provide parking for your guests, refundable parking tickets can be purchased in advance of your event via Global PMCO, telephone 82-2-6002-7130. A 50% discount is provided for Lessors upon provision of a copy of the Coex rental contract.

Security Staff Hiring

Security personnel are found throughout our center to ensure basic safety and security. Lessors holding an event where additional security is necessary may hire additional personnel through a Coex designated contractor.

Heating and Cooling

We aim for a comfortable environment in all our meeting rooms. If you find the room too warm or too cool, please notify a room manager, or pick up one of the designated house phones located throughout the meeting room areas. Air conditioning and heating are included in the cost of meeting room rental fees, but are payable via a separate Management Fee for all exhibition halls.

SERVICES PROVIDED BY Coex'S DESIGNATED SERVICE PROVIDERS

Catering

Coex's official caterer is SHINSEGAE FOOD. SHINSEGAE FOOD provide a full range of catering services including breakfasts, brunches, lunches, cocktail parties, dinners, banquets, themed parties and special events. SHINSEGAE FOOD can customize a menu to suit your theme requirements, and is ready to consult and advise on any catering needs. No outside food or drinks allowed.

Telephone: 82 2 6002 2013

Exhibition Booth Design and Construction

Exhibitors must use a Coex-designated contractor for construction of their exhibition booth. All exhibition floor plans must be approved and signed off by Coex and fire and safety officials prior to being sold on to exhibitors. Proposed plans must be provided to the marketer of Coex for approval 3 months prior to build-up and must occur prior to the sale of floor space and/or stands to Exhibitors.

Internet-Telecommunications

Internet and telecom services at Coex are provided by the following export contractors :

* Wireless Internet: SK BroadbandTel +82 2 6000 1588

* Wired Internet: KT NetTel +82 2 6000 2174

List of designated contractor:

<http://www.coex.co.kr/facility-lease/exhibition/cooperative-firm-1>

RESPONSIBILITIES OF THE EVENT HOST

Coex is dedicated to going above and beyond clients' expectations to ensure the success of each event. In order to help the planning process, please be sure to familiarize yourself with the responsibilities of the event host. The following services are not provided by Coex and must be organized separately by the Lessee:

- Desktop
- Carpeting
- Flower Arrangements
- Memo Pads & Pencils
- Signage and Banners
- Translation Services
- Quick / Parcel Services
- Water Cooling Machines

IMPORTANT CONTACT POINTS

Convention Sales Team:	+82 2 6000 1122/1123
Coex Information Desk:	+82 2 6000 0114
Coex Security Desk:	+82 2 6000 0112
Coex First Aid Room:	+82 2 6000 1119
On-Site Support by Location:	
Grand Ballroom / 101-105	+82 2 6000 7164
Conference Room(North) / 201-211	+82 2 6000 7165
Auditorium & Attached Meeting Rooms	+82 2 6000 7163
Conference Room E(Hall E) / E1-E8	+82 2 6000 7171
Conference Room(South) 3F / 300-328	+82 2 6000 7168
Conference Room(South) 4F / 400-403	+82 2 6000 7167

CONVENIENT FACILITIES

1F

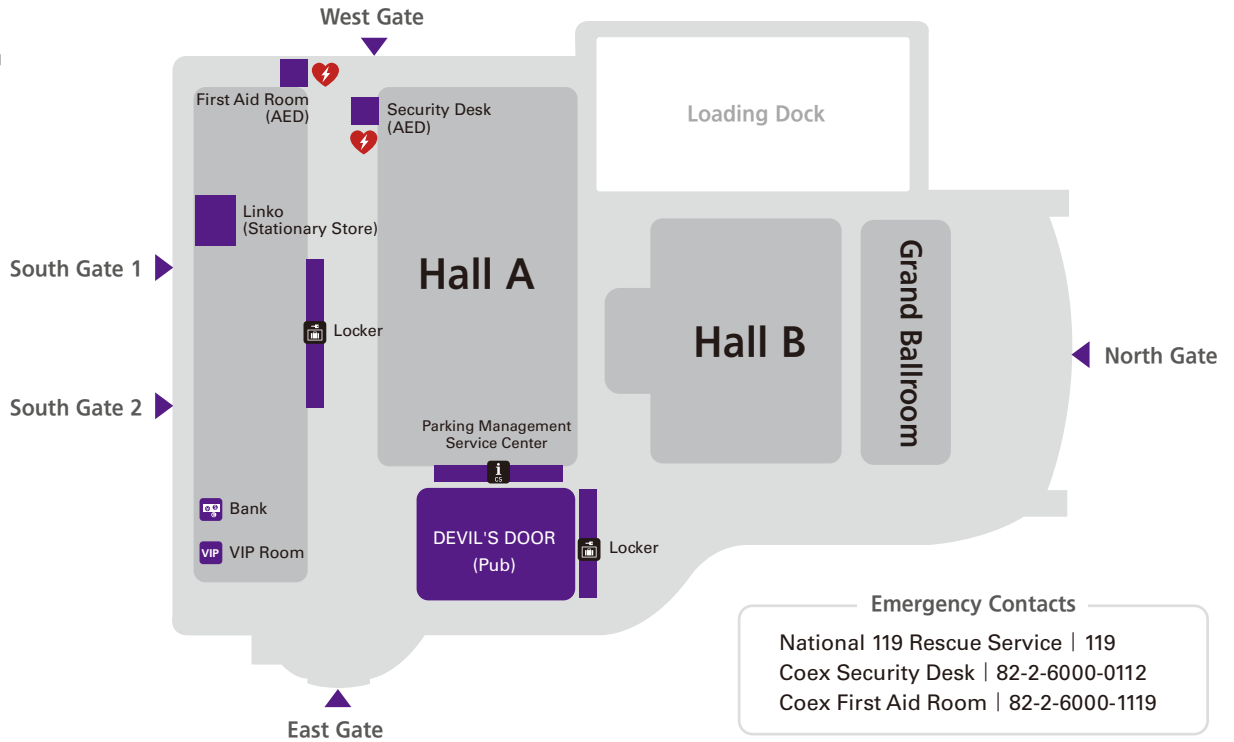

2F/3F

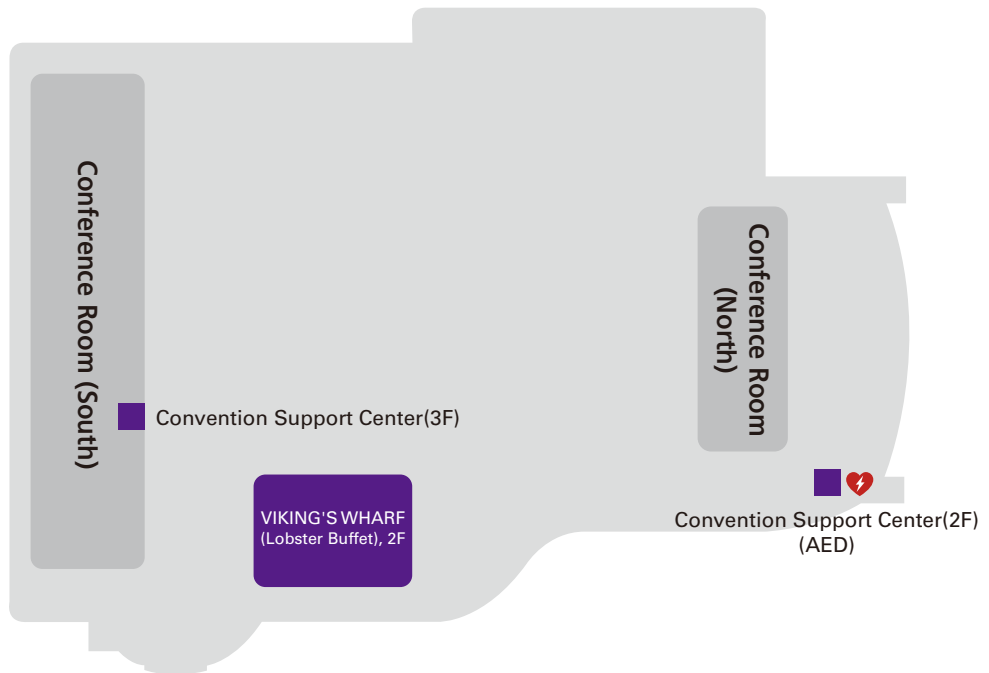

EMERGENCY EXIT LOCATIONS

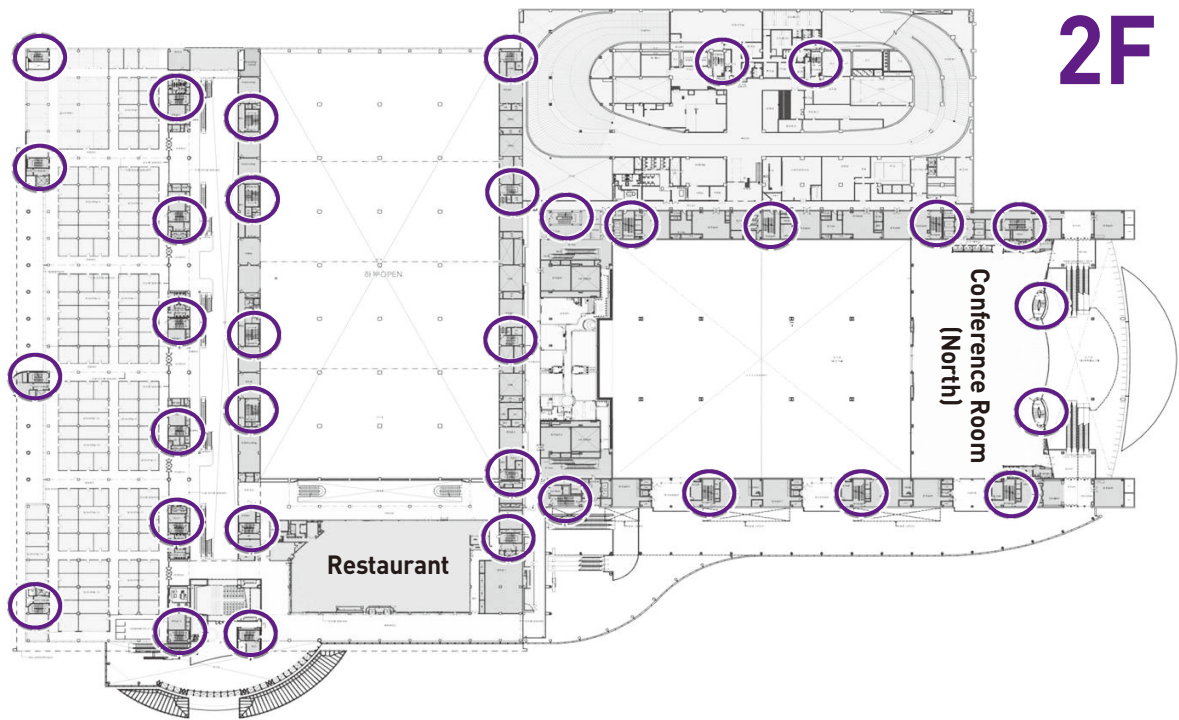
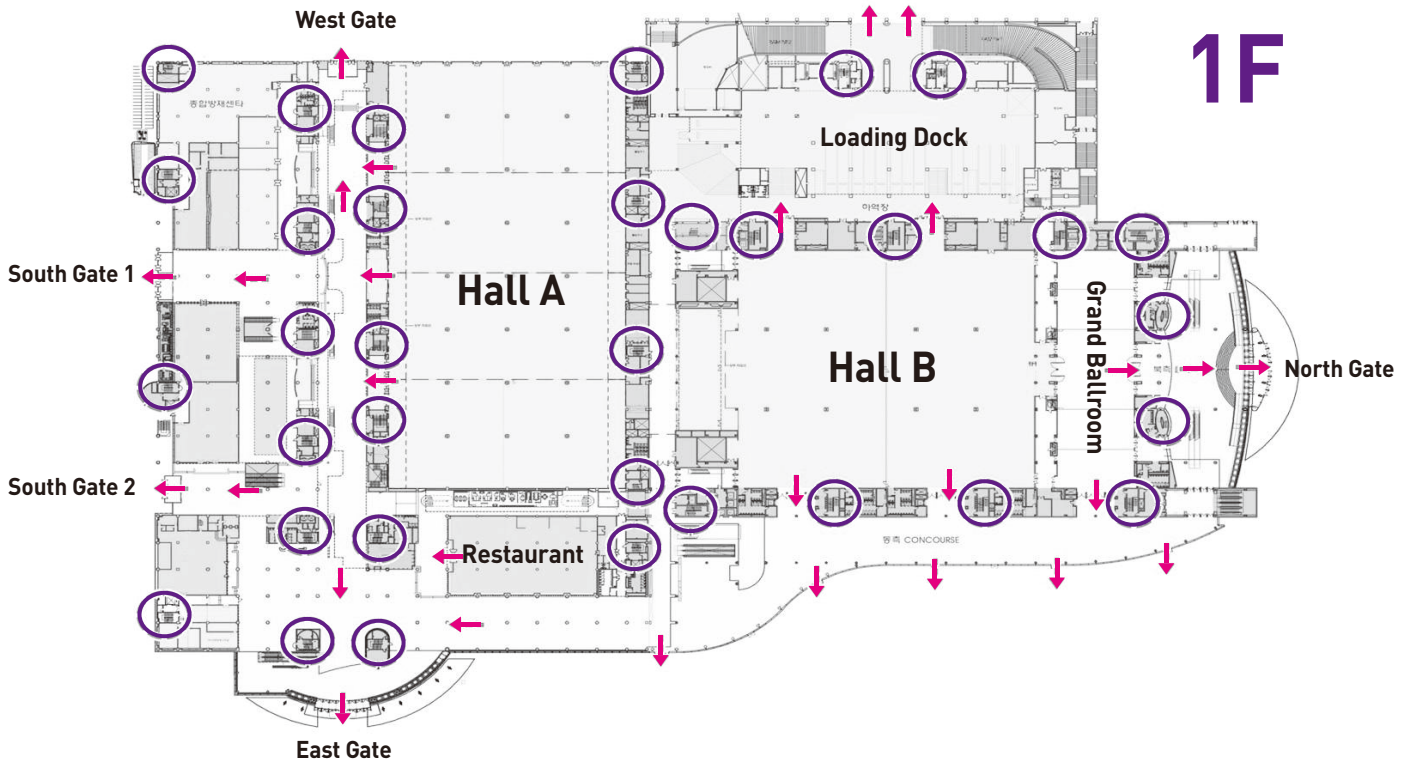

 Emergency Exit

EMERGENCY EXIT LOCATIONS

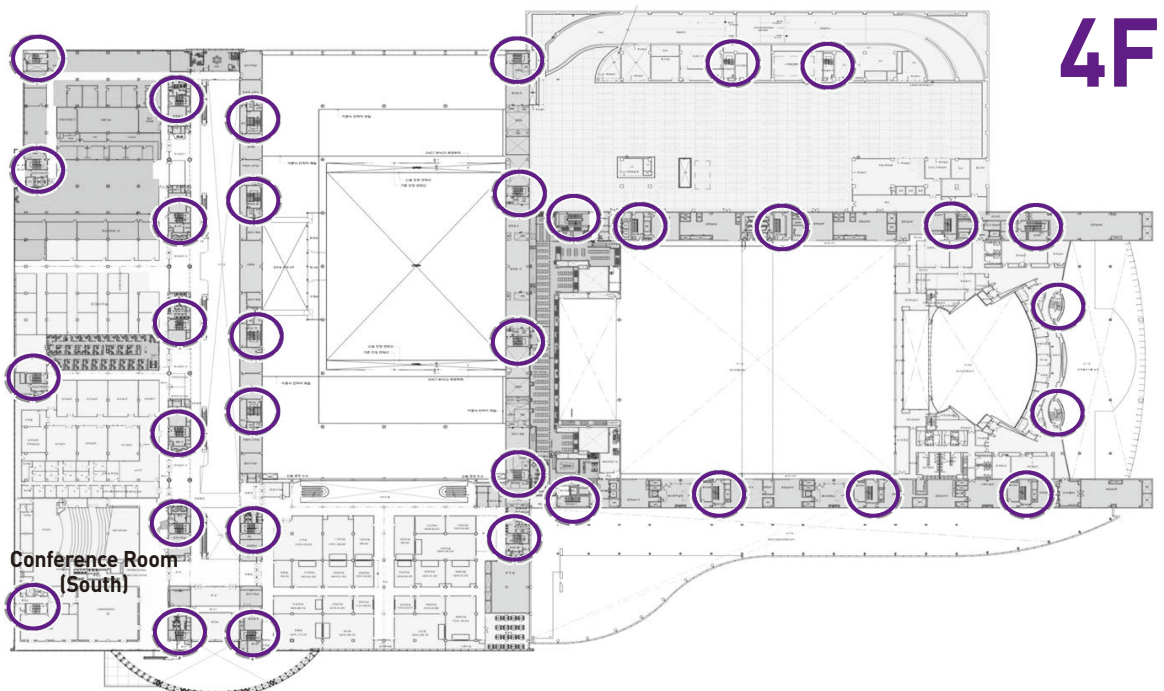
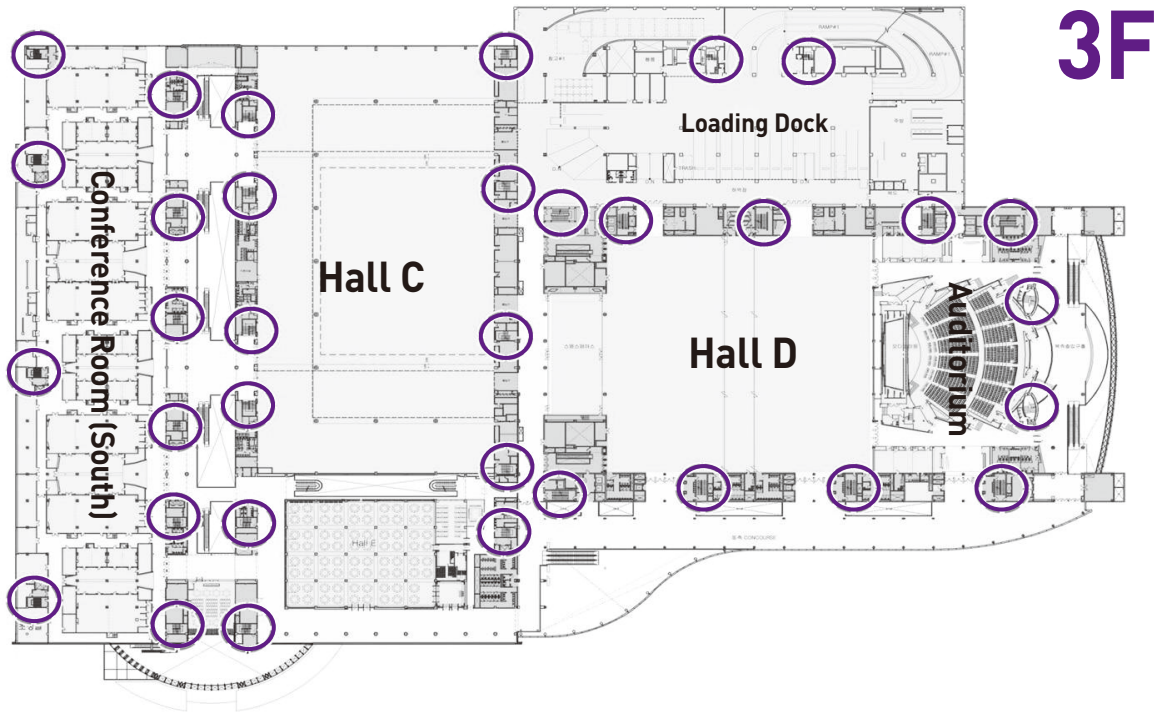

 Emergency Exit

EQUIPMENT RENTAL RATES

Our equipment rental service is offered for events hosted in our rented meeting rooms. Should you require the rental of any of the listed equipment below, please complete the “Additional Equipment Rental Request Form” in your contract and submit it to the sales manager of your event.

Description	Specification / Dimension(m)	Rental Rates (in KRW/Day, does not include V.A.T.)	Notes
LCD Projector	5,000–8,500 Lumen	Morning/Afternoon/Evening: 150,000 Full day: 250,000	Movable / Built-in
	10,000 Lumen	Morning/Afternoon/Evening: 300,000 Full day: 500,000	Room 401
Movable Portable Screen(Additional order)	2.0m x 2.0m	40,000	100 inches
Wireless Microphone	Hand or Pin	40,000	Please refer to pages 35–36 to verify how many unites are rentable per room
Conference Microphone	Table	30,000	Used by panelists or for discussions
Wired microphones	Microphone is built into the podium	20,000	For meeting rooms greater than 137m ² : Two wired microphones provided for free For meeting rooms greater than 77m ² : One wired microphone provided for free For meeting rooms less than 72m ² : Soundless
Round Table	1 table fits 10 persons	50,000	Includes table linen, Does not include linen covers for chairs
Lobby tables	1.82 x 0.76 x 0.76 (registration table) 1.82 x 0.46 x 0.76 (For Grand Ballroom, ASEM Ballroom 201–203, Conference Room E) 1.82 x 0.53 x 0.75 (For Conference Room(South) 3F/4F, Conference Room(North) 2F 204–211) 1.50 x 0.53 x 0.75 (For 40m ² meeting room in conference Room North 3F)	10,000	Should you require additional table beyond the standard complimentary tables offered
Lobby chairs		5,000	Should you require additional chairs beyond the standard complimentary chairs offered
Movable Stage	2.4m x 1.2m (Grand Ballroom, ASEM Ballroom, Conference Room E)	30,000	Includes stage skirt but not stage covers
	Partition integration/separation	100,000	Please negotiate the time for installation work with the service team
Same day room rearrangement	200,000		
Pin Board (Movable partition)	90cm(width) x 180cm(height)	5,000	Please enquire when applying

I Table size

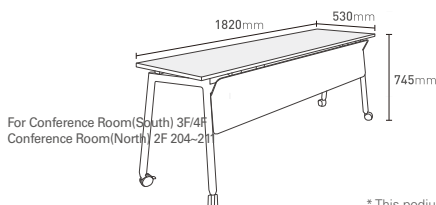
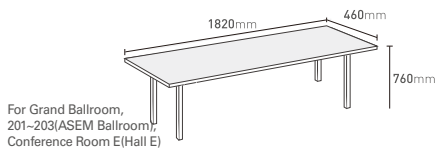
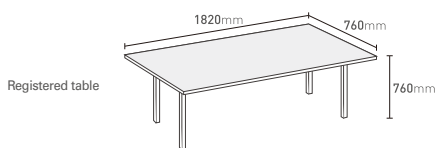

I Round table size

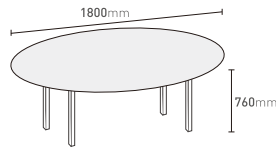

I Movable stage size

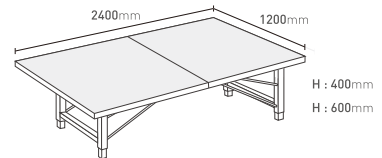

I Podium size

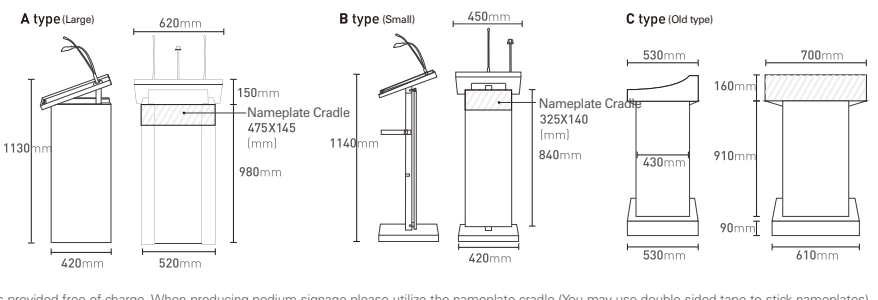

* This podium is provided free of charge. When producing podium signage please utilize the nameplate cradle.(You may use double-sided tape to stick nameplates).

EQUIPMENT RENTAL RATES (OUTSOURCING)

If you require additional equipment beyond the complimentary equipment included with your meeting room rental, you can conveniently rent what you need from an equipment provider approved and contracted by us. Please check the equipment list and rental rates below and complete an “Additional Equipment Rental Request Form” and submit it to your event’s meeting room sales manager.

Description	Specification / Dimension(m)	Rental Rates (in KRW/Day, does not include V.A.T.)	Notes
Beam Projector (including technician)	6,500 Lumen	300,000	If additional units required beyond the equipment included with your meeting room rental
	7,000 Lumen	400,000	
	12,000 Lumen	700,000	
	15,000 Lumen	900,000	
	20,000 Lumen	2,000,000	
	25,000 Lumen	2,500,000	
Seamless switch (supports dissolve function)	Input : RGB or DVI 4EA, HDMI 2EA, SDI 2EA Output : RGB/DVD/HDMI/SDI choose from 1	300,000	Supports Full HD(1920X1080)
Basic switch (Does not support dissolve function)	Input : 4 RGB ports Output : 1 RGB port	200,000	Supports HD(1920X1080)
Laptop	Core I7, 8G, SSD, 120G(and similar quality)	100,000	
	Apple Mcbook Pro	130,000	
Pointer	Per unit	7,000	
Walkie-talkie	Per unit	10,000	
LEDTV	24inch	80,000	
	55inch + stand	700,000	
LED Video Screen	200-inch + screen stand	5,100,000	LED screen extension, blending switcher, graphic design, and other services and/or rental will incur additional costs
	250-inch + screen stand	5,600,000	
	350-inch + screen stand	8,800,000	
VIP Event Furniture	Fabric sofa	80,000	Price per unit
	Leather sofa	150,000	
	Drawer chest	60,000	

Coex SERVICE PARTNER LIST

Category	Company Name	Tel.	Note
Official Caterer	SHINSEGAE FOOD	82-2-6002-2013	
F&B Shop	DEVIL'S DOOR (PUB)	82-2-6002-2001	1F
	No Brand Burger	82-2-501-1582	1F
	VIKING'S WHARF (Lobster Buffet)	82-1644-4446	2F
Parking Tickets	Global PMCO	82-2-6002-7130	
Wireless Internet	SK Broadband	82-2-6000-1588	15,000 KRW/Day
Wired Internet / Telephone	KT NET	82-2-6000-2174	49,000 KRW/Line
Coex Information Desk	Coex Information Desk	82-2-6000-0114	
Coex Security Desk	Coex Security Desk	82-2-6000-0112	
Coex First Aid Room	Coex First Aid Room	82-2-6000-1119	
On-Site Support I (Central Control Room)	Grand Ballroom / 101-105	82-2-6000-7164	Conference Room (North)
	Conference Room (North) / 201-211	82-2-6000-7165	
	Auditorium & Attached Meeting Rooms	82-2-6000-7162 / 7163	
	Conference Room E (HALL E) / E1-E8	82-2-6000-7163 / 7171	Conference Room (South)
	Conference Room (South) 3F / 300-328	82-2-6000-7166 / 7168	
	Conference Room (South) 4F/ 400-403	82-2-6000-7167	
On-Site Support II (Supervisors)	Conference Room (North) Manager	82-2-6000-1147	Conference Room (North)
	Conference Room (South) Manager	82-2-6000-1146	Conference Room (South)

* Above information is subject to change.

HALL A

Hall	Dimensions		Ceiling Height		Usable Area	
	Meters	Feet	Meters	Feet	Sq.Meters	Sq.Ft
A1	36.0 x 72.0	118.1 x 236.2	8.0 / 9.0	26.3 / 29.5	2,592	27,900
A2	36.0 x 72.0	118.1 x 236.2	8.0 / 9.0	26.3 / 29.5	2,592	27,900
A3	36.0 x 72.0	118.1 x 236.2	8.0 / 9.0	26.3 / 29.5	2,592	27,900
A4	36.0 x 72.0	118.1 x 236.2	8.0 / 9.0	26.3 / 29.5	2,592	27,900
1+2+3+4	144.0 x 72.0	472.4 x 236.2	-	-	10,368	111,600

* Ceiling height varies(refer to detailed image)

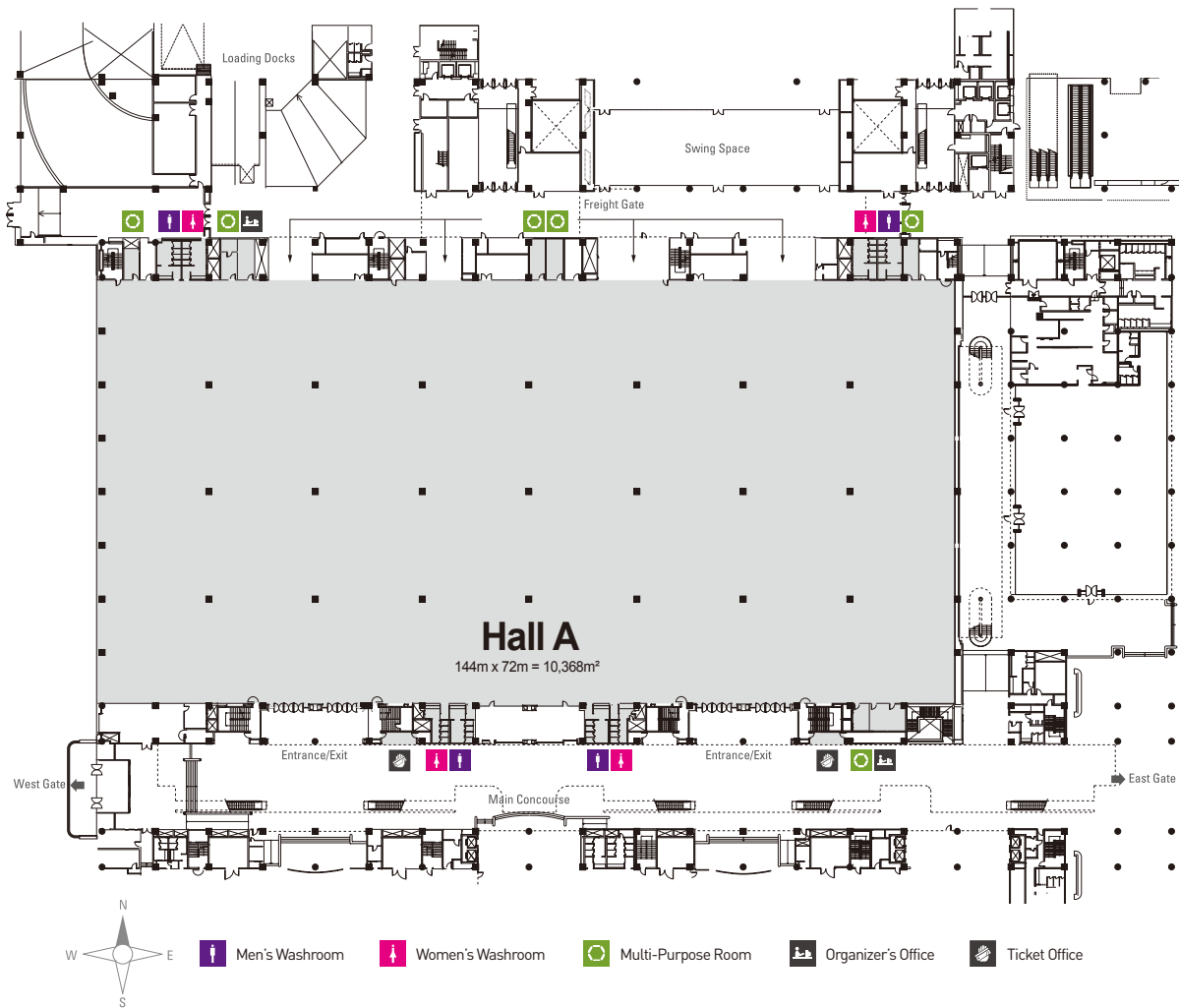

Details

Location - 1st floor

Floor Space - 10,368m² (Undividable)

Use - exhibition space, meetings, events

Capacity - 520 booths (3m x 3m)

Main Facilities - floor finish : polishing
- trench/trench box : water, air, electricity, drainage and communication service outlet

Other Facilities - space between pillars : 18m
- floor load : 1.5 tons/m²
- organizer's office : 1 per hall (for hall A2, A3 located on mezzanine level)
- multi-purpose room : 6 in exhibition hall (13m²~21m²)

HALL B

Hall	Dimensions		Ceiling Height		Usable Area	
	Meters	Feet	Meters	Feet	Sq.Meters	Sq.Ft
B1	45.0 x 81.0	1476 x 265.7	9.5	31.2	3,645	39,235
B2	45.0 x 81.0	1476 x 265.7	9.5	31.2	3,645	39,235
1+2	90.0 x 81.0	295.3 x 265.7	9.5	31.2	7,290	78,470
swing space	18.0 x 40.0	59.1 x 131.2	6.2	20.3	720	7,750

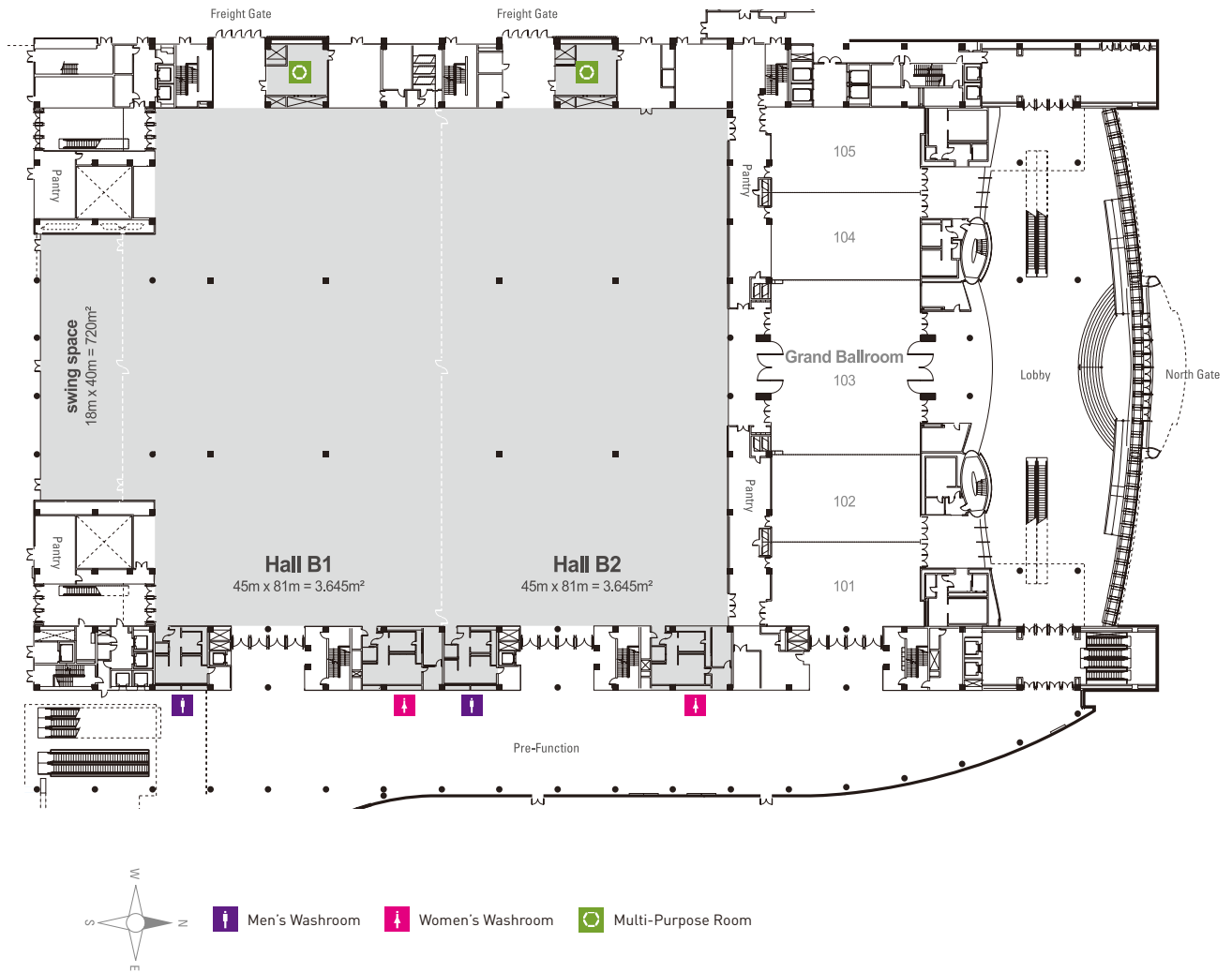

Details

Location - 1st floor

Floor Space - 8,010m² (with swing space) :
partitions into two sections

Use - exhibition space, meetings, events

Capacity - 360 booths (3m x 3m)

Main Facilities

- floor finish : color hardener
- trench/trench box : water, air, electricity, drainage and communication service outlet
- space between pillars : 18m, 27m
- floor load : 1.5 tons/m²

Other Facilities

- swing space : 720m², can be used as exhibition space, loading corridor or passageway between halls
- organizer's office : 1 per hall on mezzanine floor (126m²)
- multi-purpose room : 1 per hall at freight gate (60m²)

HALL C

Hall	Dimensions		*Ceiling Height		Usable Area	
	Meters	Feet	Meters	Feet	Sq.Meters	Sq.Ft
C1	36.0 x 72.0	118.1 x 236.2	8.0	26.3	2,572	27,900
C2	36.0 x 72.0	118.1 x 236.2	12.3	40.4	2,592	27,900
C3	36.0 x 72.0	118.1 x 236.2	12.3	40.4	2,592	27,900
C4	36.0 x 72.0	118.1 x 236.2	8.0	26.3	2,592	27,900
1+2+3+4	144.0 x 72.0	472.4 x 236.2	-	-	10,348	111,600

* Ceiling height varies (refer to detailed image)



Details

Location - 3rd floor

Floor Space - 10,348m² : partitions into three sections (organizers can create partition between C2, C3)

Use - exhibition space, meetings, events

Capacity - 520 booths (3m x 3m)

Main Facilities

- floor finish : polishing
- trench/trench box : water, air, electricity, drainage and communication service outlets
- space between pillars : 18m
- floor load : 1.5 tons/m²

Other Facilities

- organizer's office : 1 per hall (hall C2, C3 located on mezzanine level)
- multi-purpose room : 6 in exhibition hall (23m²~ 62m²)

HALL D

Hall	Dimensions		Ceiling Height		Usable Area		Capacities		
	Meters	Feet	Meters	Feet	Sq.Meters	Sq.Ft	CL	TH	BQ
D1	36.0 x 81.0	118.1 x 265.7	17.5	57.4	2,916	31,388	1,600	3,200	1,600
D2	45.0 x 81.0	147.6 x 265.7	17.5	57.4	3,645	39,235	1,900	3,800	1,900
1+2	81.0 x 81.0	265.7 x 265.7	17.5	57.4	6,561	70,623	3,500	7,000	3,500
swing space	18.0 x 40.0	59.1 x 131.2	9.3	30.5	720	7,750			

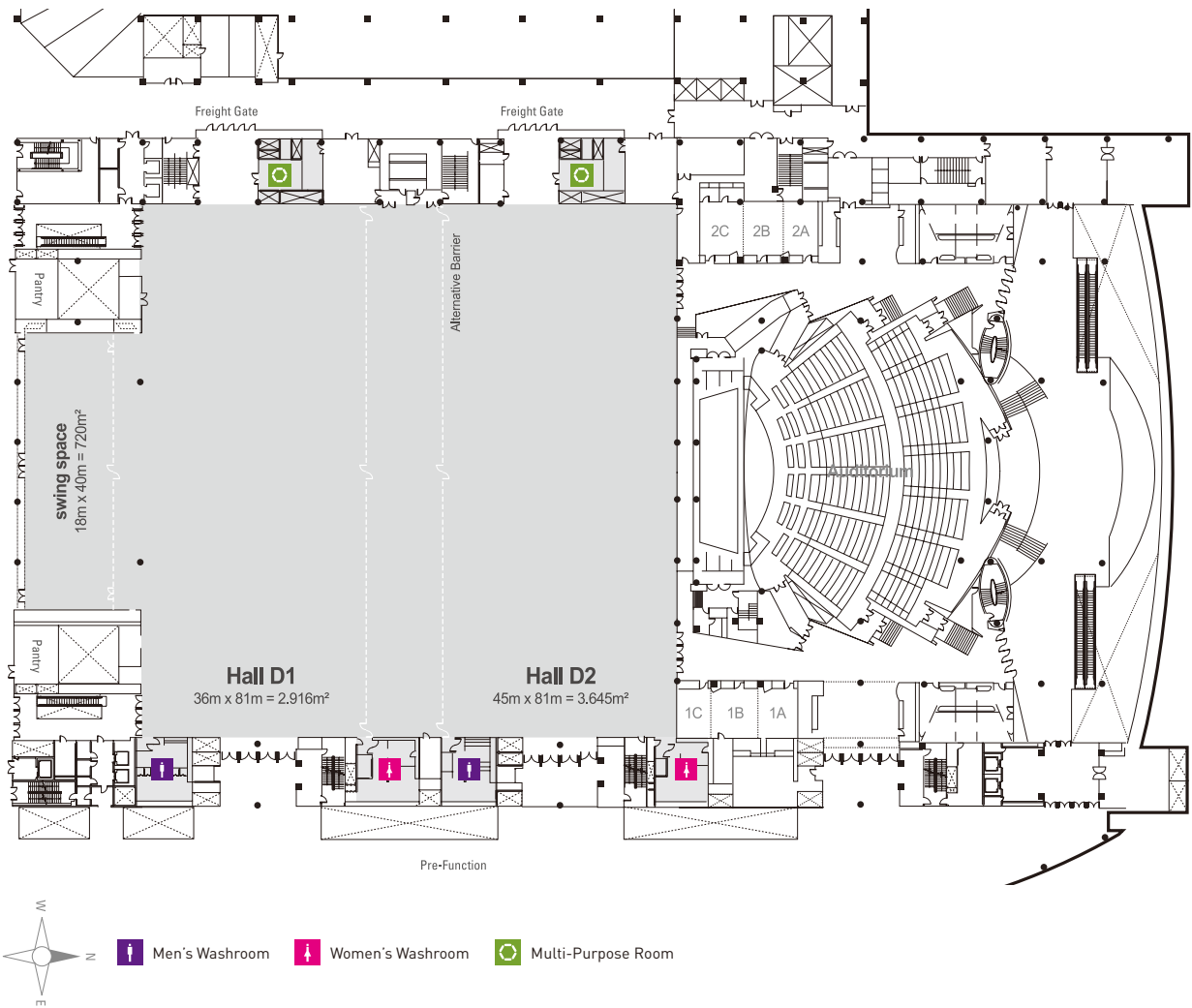

Details

Location - 3rd floor

Floor Space - 7,281m² (with swing space) :
partitions into two sections

Use - large int'l meetings, banquets, fashion shows,
political rallies, award ceremonies, etc.

Capacity - 360 booths (3m x 3m) or maximum 7,500 people

Main Facilities - floor finish : color-hardened floor
- trench/trench box : water, air, electricity, drainage and
communication service outlets
- column-free
- floor load : 1.5 tons/m²

Other Facilities - swing space : (720m²) for stage set up, as loading corridor
or exhibition space
- organizer's office : 1 per hall on 4th floor (126m²)
- multi-purpose room : 1 per hall at freight gate (32.5m²)

GRAND BALLROOM

Venue	Dimensions		Area		Capacity		
	W x L x H (m)	W x L x H (ft)	m ²	ft ²	CL	TH	BQ
101	13x22.3x4.5	42.7x73.2x14.8	299	3,218	144	300	150
102	13x22.3x4.5	42.7x73.2x14.8	299	3,218	144	300	150
103	26.9x22.3x4.5	88.3x73.2x14.8	621	6,684	300	600	300
104	13x22.3x4.5	42.7x73.2x14.8	299	3,218	144	300	150
105	12.9x22.3x4.5	42.3x73.2x14.8	299	3,218	144	300	150
101-105	79x22.3x4.5	259.2x73.2x14.8	1,817	19,558	900	1,800	900

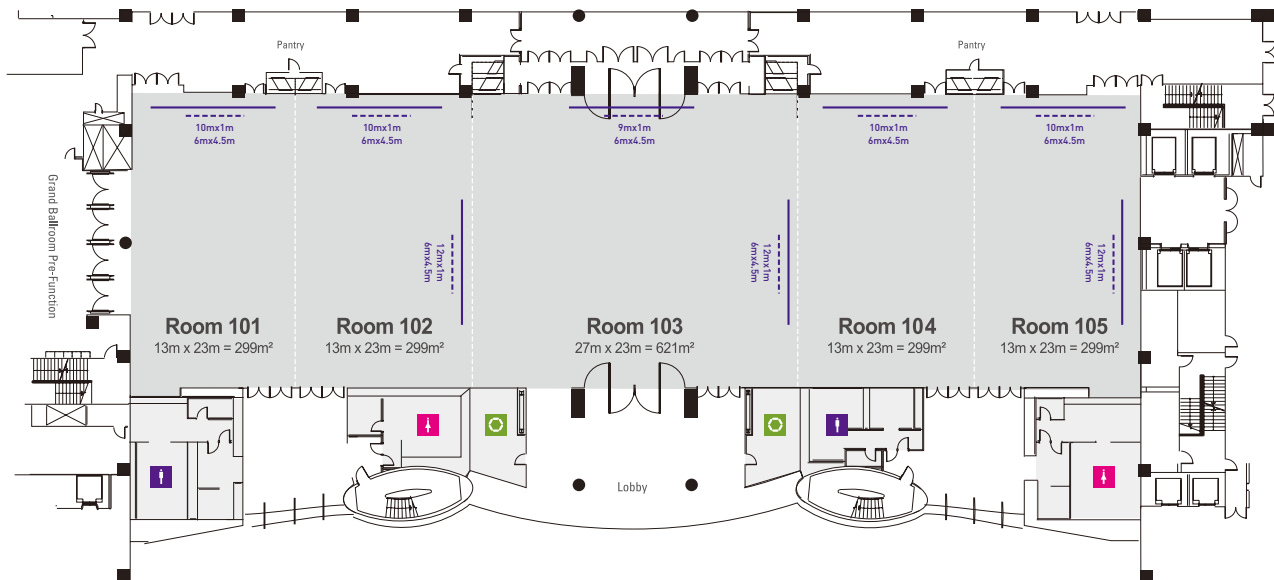

Details

Location	- 1st floor	Main Facilities	- A/V and lighting system - auto screens : (4m x 3m), (6m x 4m) - battens : 9m, 10m, 12m
Floor Space	- 1,817m ² : partitions into 5 sections	Other Facilities	- column-free - 2 multi-purpose rooms at 21m ² each, can be used as coat rooms and VIP rooms
Use	- Int'l meetings, banquets, various events, etc.		
Capacity	- 80 exhibit booths (3m x 2m), 1,800 people		

CONFERENCE ROOM NORTH

Venue	Dimensions		Area		Capacity		
	W x L x H (m)	W x L x H (ft)	m ²	ft ²	CL	TH	BQ
201	14.5x23x3.7	47.6x75.5x12.1	341	3,670	180	300	150
202	15.2x23x3.7	49.9x75.5x12.1	341	3,670	180	300	150
203	14.5x23x3.7	47.6x75.5x12.1	341	3,670	180	300	150
201-203 (ASEM Ballroom)	44.2x23x3.7	145x75.5x12.1	1,023	11,011	540	900	500-550
204	9.9x2.8x2.9	32.5x9.2x9.5	28	301	10	-	-
205A	11x7x2.9	36.1x23x9.5	77	829	45	80	30
205B	11x7x2.9	36.1x23x9.5	77	829	45	80	30
205	11x14x2.9	72.2x23x9.5	154	1,658	90	160	70
206A	4.7x6.8x2.9	15.4x22.3x9.5	32	344	18	30	10
206B	4.7x6.8x2.9	15.4x22.3x9.5	32	344	14	25	10
206	9.4x6.8x2.9	30.8x22.3x9.5	64	689	32	55	20
207	4.4x6.8x2.9	14.4x22.3x9.5	32	344	18	30	10
208	9.9x2.8x2.9	32.5x9.2x9.5	28	301	10	-	-
209A	11x7x2.9	36.1x23x9.5	77	829	45	80	30
209B	11x7x2.9	36.1x23x9.5	77	829	45	80	30
209	11x14x2.9	72.2x23x9.5	154	1,658	90	160	70
210A	4.7x6.8x2.9	15.4x22.3x9.5	32	344	18	30	10
210B	4.7x6.8x2.9	15.4x22.3x9.5	32	344	14	25	10
210	9.4x6.8x2.9	30.8x22.3x9.5	64	689	32	55	20
211	4.4x6.8x2.9	14.4x22.3x9.5	32	344	18	30	10

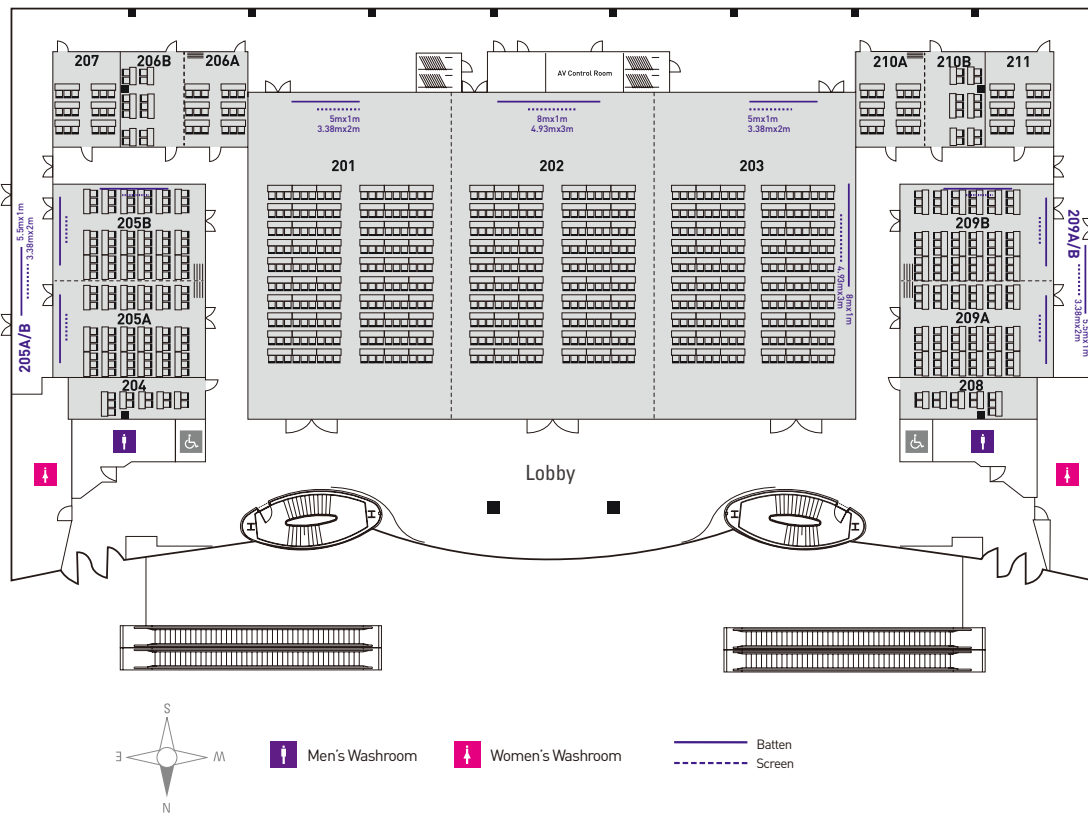

Details

201~203(ASEM Ballroom)		204~211	
Location	- 2nd floor	Location	- 2nd floor
Floor Space	- 341m ² (3)	Floor Space	- 28m ² (2), 32m ² (2), 64m ² (2), 154m ² (2) partitions into 12 sections
Use	- Int'l meetings, banquets, various events, etc.	Use	- Workshops, seminars, executive offices, waiting rooms, etc.
Main Facilities	- A/V system - Projector - Auto screen : 150°, 3.38m x 2m (201, 203) 200°, 4.93m x 3m (202, 203)	Main Facilities	- A/V system (205, 209) - Projector (205, 209) - Auto screen : 150°, 3.38m x 2m (205, 209)

AUDITORIUM

Venue	Dimensions		Area		Capacity		
	W x L x H (m)	W x L x H (ft)	m ²	ft ²	CL	TH	BQ
Auditorium	37x31	121.4x101.7	2,104	22,647	-	1,080	-

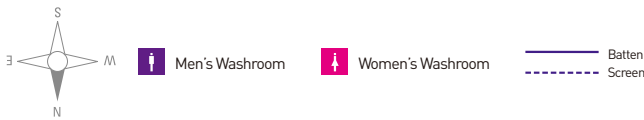
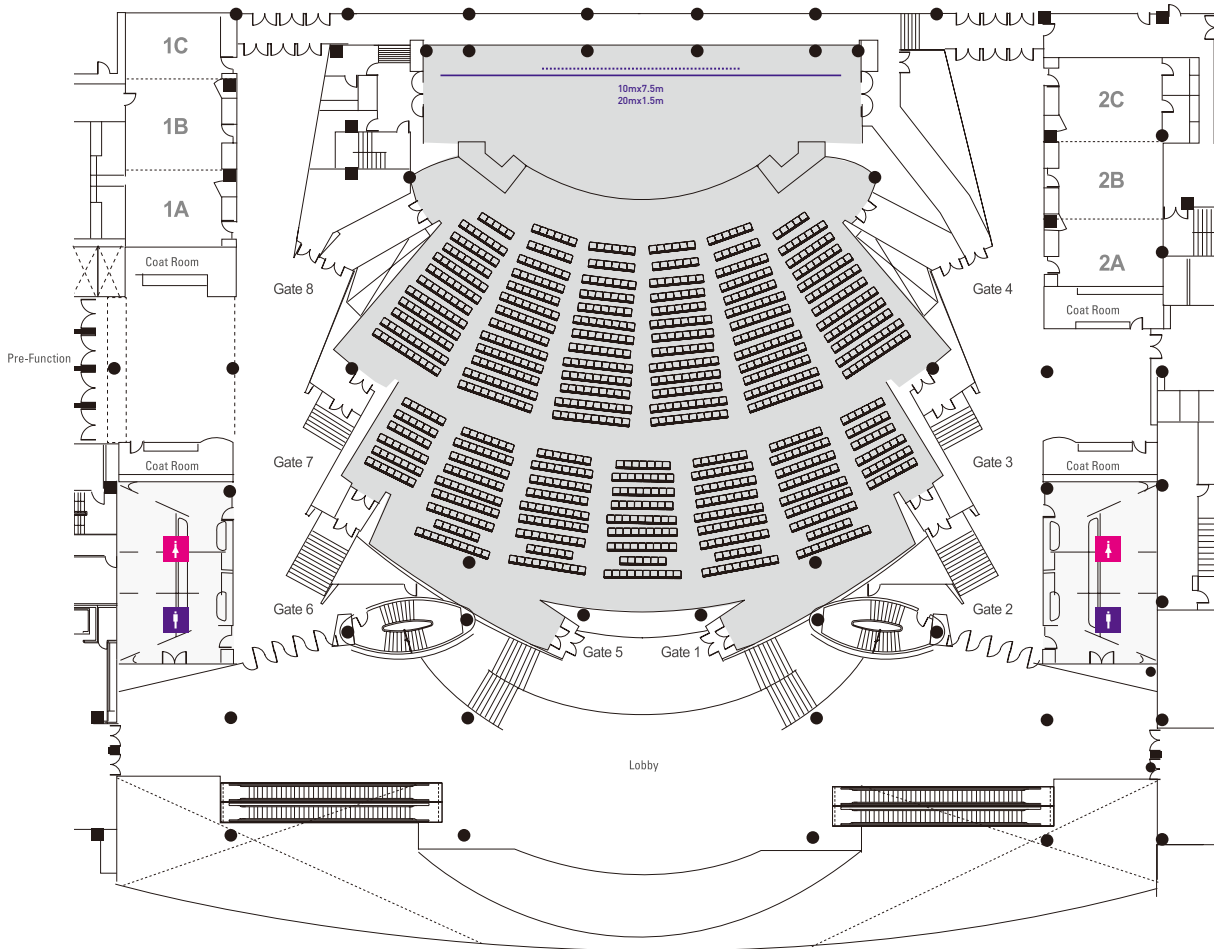

Details

Location - 3rd floor

Floor Space - 2,104m²

Use - International conferences, awards ceremonies, stage-based events, musicals, etc.

Capacity - 1,080 seats (theater seating)

Main Facilities

- AV and lighting system
- translation booths (4th floor)
- stage : 12m (W) x 24m (L) x 11m (H)
- screen : 20m x 7m
- 2 screens (240" each)

Other Facilities

- 4 coat rooms (3rd floor)
- Auditorium Meeting Rooms

AUDITORIUM MEETING ROOMS

Venue	Dimensions		Area		Capacity		
	W x L x H (m)	W x L x H (ft)	m ²	ft ²	CL	TH	BQ
R1	7.4x18x5.6	24.3x59.1x18.4	144	1,550	72	140	60
R2	7.4x18x5.6	24.3x59.1x18.4	144	1,550	72	140	60
R3	7.4x12.4x3.5	24.3x40.7x11.5	104	1,119	54	100	40
R4	7.4x12.4x3.5	24.3x40.7x11.5	104	1,119	54	100	40

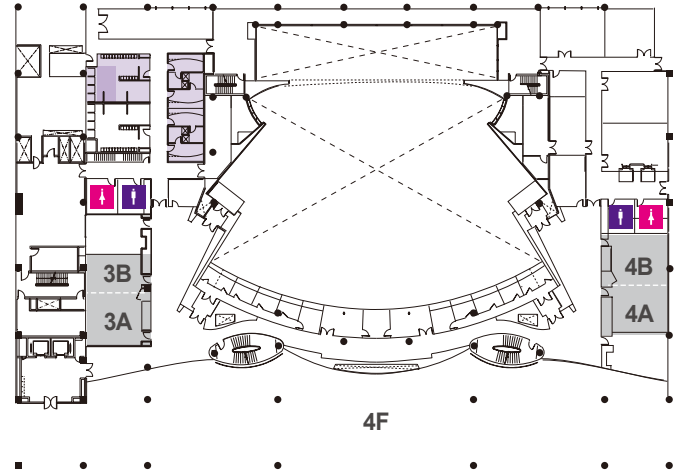
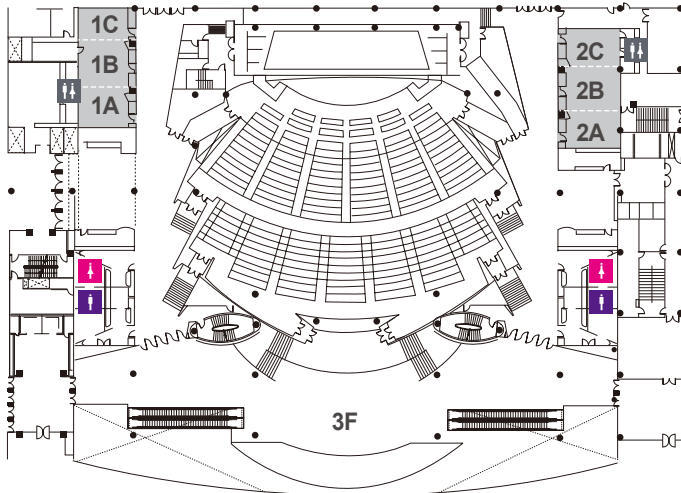

 Dressing Room

 Unisex Washroom (Inside the meeting room)

 Men's Washroom

 Women's Washroom

Details

Location - 3rd and 4th floor

Floor Space - 144m² (2), 104m² (2), partitions into ten sections

Use - VIP rooms, secretariats, media rooms, etc.

Main Facilities - A/V system

CONFERENCE ROOM E (HALL E)

Venue	Dimensions		Area		Capacity		
	W x L x H (m)	W x L x H (ft)	m ²	ft ²	CL	TH	BQ
E1	9.7x18.7x3.6	31.8x61.4x11.8	182	1,953	81	160	80
E2	8.9x16.7x3.6	29.2x54.8x11.8	149	1,601	72	140	70
E3	8.9x16.7x3.6	26.2x54.8x11.8	134	1,436	72	140	70
E4	8x18.7x3.6	26.6x61.4x11.8	152	1,634	81	160	70
E1~E4	35.8x18.7x3.6	117.5x61.4x11.8	617	6,624	306	600	300
E5	18.7x18.7x3.6	61.4x61.4x11.8	350	3,770	162	320	160
E6	18.7x17x3.6	61.4x55.8x11.8	318	3,427	162	320	160
E5~E6	18.7x35.8x3.6	61.4x117.5x11.8	668	7,197	324	640	300
E1~E6	44.8x35.8x3.6	147.0x117.5x11.8	1,604	17,273	810	1,500	600
E7	9.1x14.7x3.5	29.9x48.3x11.5	134	1,445	72	140	60
E8	5.1x8.9x3.3	16.8x29.2x10.9	46	491	24	40	20

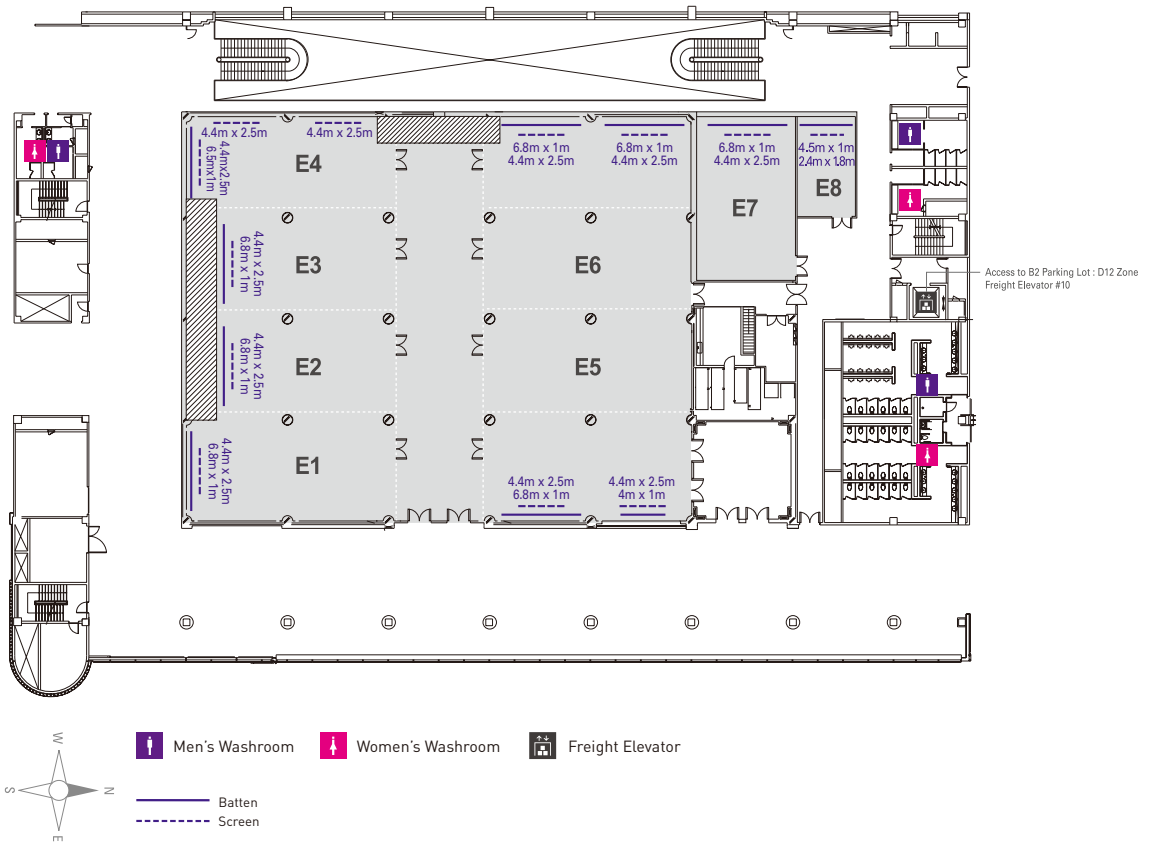

Details

Location	- 3rd floor	Main Facilities	- A/V system - auto screens (4.4m x 2.5m), (2.4m x 1.8m) - battens (6.5m x 1m), (6.8m x 1m), (4.5m x 1m), (4m x 1m) - fixed Projector: 8,000 Lumen
Floor Space	- 1,784m ² : partitions into 8 sections		
Use	- seminars, banquets, exhibitions, long-term events, etc.		
Capacity	- 1,500 people		

CONFERENCE ROOM SOUTH 3F



Venue	Dimensions		Area		Capacity		
	W x L x H (m)	W x L x H (ft)	m ²	ft ²	CL	TH	BQ
300	14x18x3.5	45.9x59.1x11.5	264	2,842	126	240	100
301A	7.3x12.7x3.3	24x41.7x10.8	104	1,119	54	100	50
301B	12.7x9.7x3.3	41.7x31.8x10.8	103	1,109	48	100	30
301	12.7x17.9x3.3	41.7x58.7x10.8	207	2,228	99	200	80
302	3.8x9x3.1	12.5x29.5x10.2	40	431	20	36	20
303	3.9x9.5x3.1	12.8x31.2x10.2	40	431	20	36	20
304	6.2x9x3.1	20.3x29.5x10.2	54	581	24	48	30
305	6.2x9x3.1	20.3x29.5x10.2	54	581	24	48	30
306	3.8x9x3.1	12.5x29.5x10.2	40	431	20	36	10
307A	8x12.9x3.3	26.2x42.3x10.8	104	1,119	54	100	50
307B	10x12.9x3.3	32.8x42.3x10.8	104	1,119	54	100	50
307C	12.9x8.5x3.3	42.3x27.9x10.8	103	1,109	48	100	30
307	12.9x26.8x3.3	42.3x87.9x10.8	311	3,348	156	300	150
308A	8x12.9x3.3	26.2x42.3x10.8	104	1,119	54	100	50
308B	10x12.9x3.3	32.8x42.3x10.8	104	1,119	54	100	50
308C	12.9x8.5x3.3	42.3x27.9x10.8	103	1,109	48	100	30
308	12.9x26.8x3.3	42.3x87.9x10.8	311	3,348	156	300	150
309	3.9x9.5x3.1	12.8x31.2x10.2	40	431	20	36	20
310	6.2x9x3.1	20.3x29.5x10.2	54	581	24	48	30
311	6.2x9x3.1	20.3x29.5x10.2	54	581	24	48	30
312	3.8x9x3.1	12.5x29.5x10.2	40	431	20	36	20
313	3.9x9.5x3.1	12.8x31.2x10.2	40	431	20	36	20
314	6.2x9x3.1	20.3x29.5x10.2	54	581	24	48	30
315	6.2x9x3.1	20.3x29.5x10.2	54	581	24	48	30
316	3.8x9x3.1	12.5x29.5x10.2	40	431	20	36	20
317A	8x12.9x3.3	26.2x42.3x10.8	104	1,119	54	100	50
317B	10x12.9x3.3	32.8x42.3x10.8	104	1,119	54	100	50
317C	12.9x8.5x3.3	42.3x27.9x10.8	103	1,109	48	100	30
317	12.9x26.8x3.3	42.3x87.9x10.8	311	3,348	156	300	150
318A	8x12.9x3.3	26.2x42.3x10.8	104	1,119	54	100	50
318B	10x12.9x3.3	32.8x42.3x10.8	104	1,119	54	100	50
318C	12.9x8.5x3.3	42.3x27.9x10.8	103	1,109	48	100	30
318	12.9x26.8x3.3	42.3x87.9x10.8	311	3,348	156	300	150
319	3.9x9.5x3.1	12.8x31.2x10.2	40	431	20	36	20
320	6.2x9x3.1	20.3x29.5x10.2	54	581	24	48	30
321	6.2x9x3.1	20.3x29.5x10.2	54	581	24	48	30
322	3.8x9x3.1	12.5x29.5x10.2	40	431	20	36	20
323	3.9x9.5x3.1	12.8x31.2x10.2	40	431	20	36	20
324	6.2x9x3.1	20.3x29.5x10.2	54	581	24	48	30
325	6.2x9x3.1	20.3x29.5x10.2	54	581	24	48	30
326	3.8x9x3.1	12.5x29.5x10.2	40	431	20	36	20
327A	8x12.9x3.3	26.2x42.3x10.8	104	1,119	54	100	50
327B	10x12.9x3.3	32.8x42.3x10.8	104	1,119	54	100	50
327C	12.9x8.5x3.3	42.3x27.9x10.8	103	1,109	48	100	30
327	12.9x26.8x3.3	42.3x87.9x10.8	311	3,348	156	300	150
328	6.6x13.9x2.9	21.7x45.6x9.5	96	1,033	48	100	40

Details

Location - 3rd floor

Main Facilities

- A/V system (room larger than 207m²)
- fixed projectors : LCD 6200 Lumen(ceiling mounted)
- translation booths (room larger than 207m²) *except 308
- fixed stage : 8m x 3m x 0.2m (room larger than 207m²)
- batten (room larger than 103m²)

Floor Space - 40m² (11), 54m² (10), 207m² (1), 262m² (1), 310m² (5) partition into 50 sections

Use - various conferences, small seminars, workshops, banquets, events, etc.

Capacity - 20~300 people

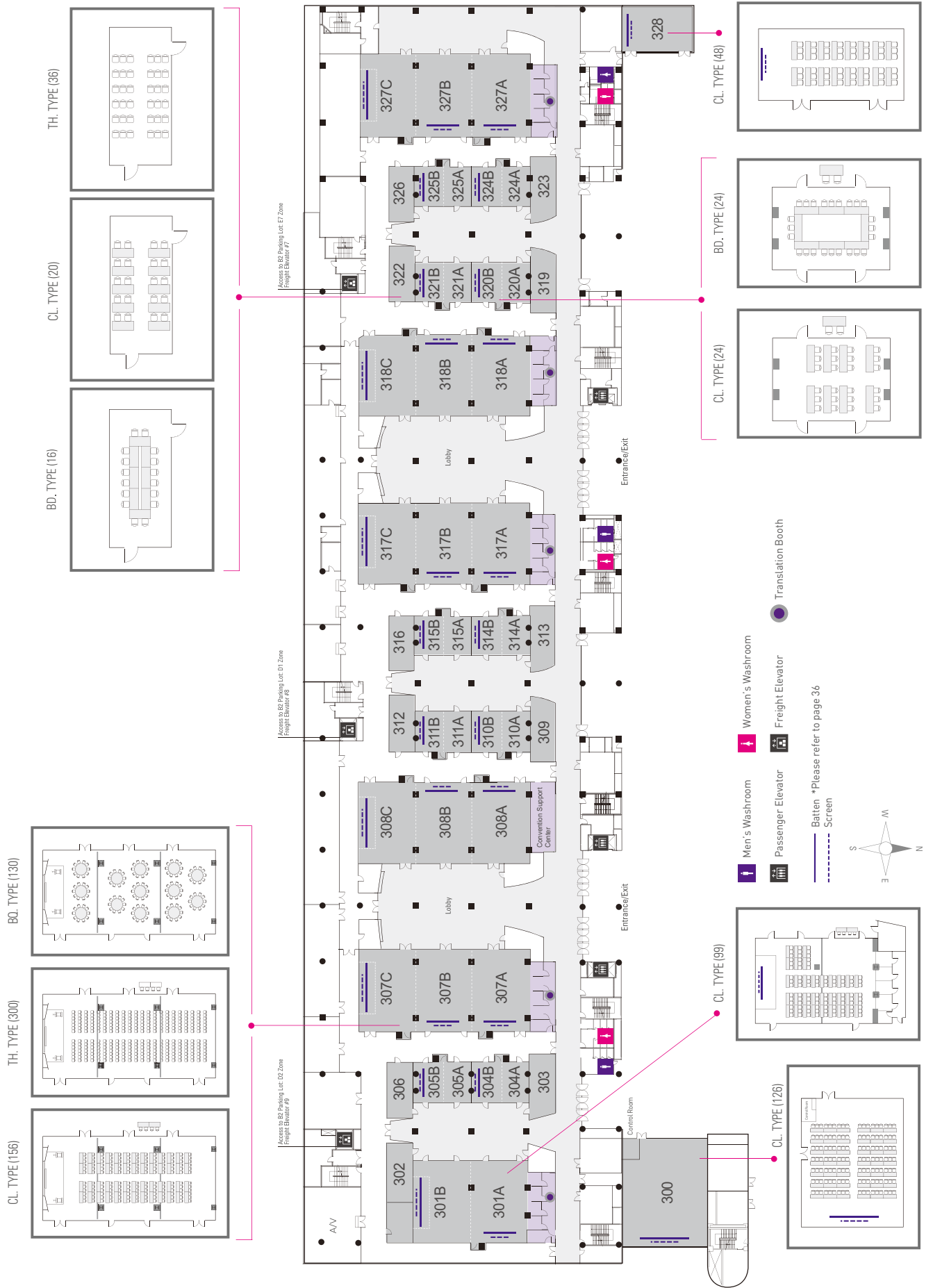

CONFERENCE ROOM SOUTH 4F

Venue	Dimensions		Area		Capacity		
	W x L x H (m)	W x L x H (ft)	m ²	ft ²	CL	TH	BQ
400	5.6x13.8x3.4	18.4x45.3x11.2	78	834	(Fixed Type) BD 22		
401	16x34x7	52.5x111.5x23	489	5,264	(Fixed Type) TH 441		
402	16.9x16.5x3.4	55.4x54.1x11.2	324	3,488	168	312	160
403	8x16x3.2	26.2x52.5x10.5	144	1,550	72	144	60

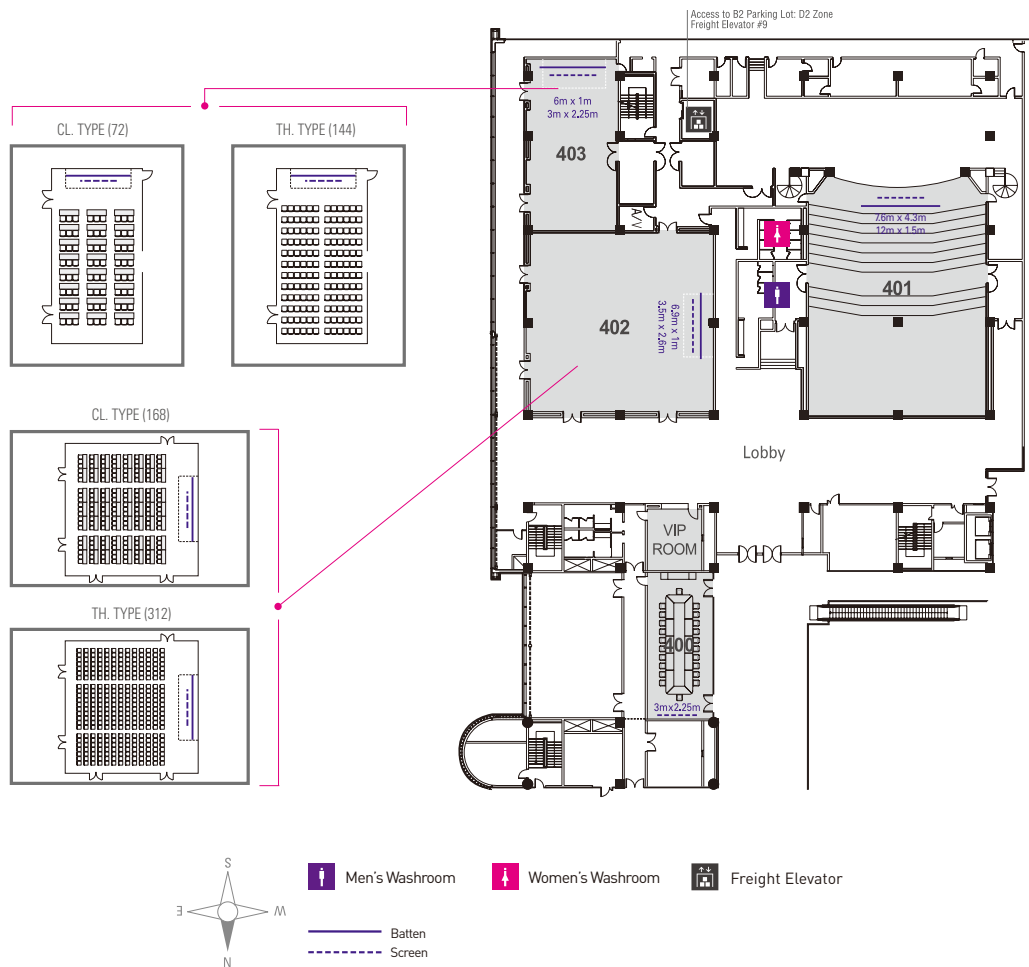

Details

	401	400, 402~403
Location	- 4th floor	Location - 4th floor
Floor Space	- 489m ² (1)	Floor Space - 78m ² (1), 144m ² (1), 324m ² (1)
Use	- Int'l conferences, symposia, seminars, award ceremonies, musicals, showcases, etc.	Use - 400 : VIP lounge, board meeting, etc.(fixed type) - 402~403 : meetings, educational sessions, banquets, etc.
Capacity	- 441 seats (theater-style conference room)	Capacity - 22(400), 140~300 people(402~403)
Main Facilities	- stage lighting and A/V system - translation booths - stage : 9.4m (W) x 13m (L) x 6m (H) - auto screen : 7.6m x 4.3m - batten : 12m x 1m	Main Facilities - A/V system - stage : 3m x 11m x 0.2m(402), 2.5m x 6m x 0.2m(403) - auto screen : 3.3 x 1.85m(400), 3.6 x 2.7m(402), 3m x 2m(403) - batten : 7m x 1m(402), 6m x 1m(403)

FACILITY CHART

MEETING ROOMS

* All standard meeting rooms for 50 or more pax includes one complimentary podium (equipped with a wired microphone) and one complimentary lobby registration table with two chairs.

Venue	Dimensions W x L x H (m)	Area(m ²)	Capacity			Banner				Beam Projector		Stage(m) (Width x Length x Height)	Etc		
			CL	TH	BQ	Horizontal banner(m) (Width x Length)	Vertical banner(m) (Width x Length)	Banner (batten) Location	Banner display method	Screen (m) (Width x Length)	Projector (Lumen)		Number of rentable wireless microphones	Type of podium	
Grand Ballroom	101	13x22.3x4.5	299	144	300	150	10x1	1.5x4.5	Behind the screen	Tack/Cable tie	6x4.5(300")	Mobile 5,000-7,000	Mobile stage (per 1 unit 2.4x1.2x0.6)	2	A/B (1 each)
	102	13.22.3x4.5	299	144	300	150	10x1/12x1	1.5x4.5	Behind the screen	Tack/Cable tie	6x4.5(300")			2	A/B (1 each)
	103	26.9x22.3x4.5	621	300	600	300	9x1/12x1	1.5x4.5	Behind the screen	Tack/Cable tie	6x4.5(300")			4	A/B (1 each)
	104	13x22.3x4.5	299	144	300	150	10x1	1.5x4.5	Behind the screen	Tack/Cable tie	6x4.5(300")			2	A/B (1 each)
	105	12.9x22.3x4.5	299	144	300	150	10x1/12x1	1.5x4.5	Behind the screen	Tack/Cable tie	6x4.5(300")			2	A/B (1 each)
	101-105	79x22.3x4.5	1,817	900	1,800	900	Negotiable	1.5x4.5	Behind the screen	Tack/Cable tie	6x4.5(300")			Negotiable	Negotiable
	Lobby						15x3(ceiling)		*Lift required						
Conference Room (North), 2F	201	14.5x23x3.7	180	300	150	150	5x1	1x2.3	Behind the screen	Magnet/Cable tie	3.38x2 (150")wide	7,000 (DLP/WUXGA)	Mobile stage (per 1 unit 2.4x1.2x0.4)	2	A/B (1 each)
	202	15.2x23x3.7	180	300	150	150	8x1	1.5x2.9	Behind the screen	Magnet/Cable tie	4.93x3 (220")wide	8,500 (DLP/WUXGA)		2	A/B (1 each)
	203	14.5x23x3.7	180	300	150	150	5x1/8x1	1x2.3	Behind the screen	Magnet/Cable tie	3.38x2 (150")wide	7,000/8,500 (DLP/WUXGA)		2	A/B (1 each)
	201-203 (ASEM Ballroom)	44.2x23x3.7	540	900	550	500-550	8x1	1x2.3 1.5x2.9	Behind the screen	Magnet/Cable tie	3.38/4.93x2 (150/220")wide	7,000/8,500 (DLP/WUXGA)	Negotiable	Negotiable	
	204	9.9x2.8x2.9	10	-	-	-	-	-	-	-	-	-	-	-	On request
	205A	11x7x2.9	45	80	30	30	5.5x1	1x2.3	Behind the screen	Magnet/Cable tie	3.38x2 (150")wide	5,000	-	1	1 B
	205B	11x7x2.9	45	80	30	30	5.5x1	1x2.3	Behind the screen	Magnet/Cable tie	3.38x2 (150")wide	5,000	-	1	1 B
	205	22x7x2.9	90	160	70	70	5.5x1	1x2.3	Behind the screen	Magnet/Cable tie	3.38x2 (150")wide	5,000	-	2	2 B
	206A	4.7x6.8x2.9	18	30	10	10	-	-	-	-	(Mobile) LED Electronic Blackboard 1,663(W)x985(H)x103(D) or Mobile Screen(100") + Mobile Projector 5,000	-	-	On request	
	206B	4.7x6.8x2.9	14	25	10	10	-	-	-	-		-	-		
	206	9.4x6.8x2.9	32	55	20	20	-	-	-	-		-	-		
	207	4.4x6.8x2.9	18	30	10	10	-	-	-	-		-	-		
	208	9.9x2.8x2.9	10	-	-	-	-	-	-	-		-	-		
	209A	11x7x2.9	45	80	30	30	5.5x1	1x2.3	Behind the screen	Magnet/Cable tie	3.38x2 (150")wide	5,000	-	1	1 B
	209B	11x7x2.9	45	80	30	30	5.5x1	1x2.3	Behind the screen	Magnet/Cable tie	3.38x2 (150")wide	5,000	-	1	1 B
	209	22x7x2.9	90	160	70	70	5.5x1	1x2.3	Behind the screen	Magnet/Cable tie	3.38x2 (150")wide	5,000	-	2	2 B
210A	4.7x6.8x2.9	18	30	10	10	-	-	-	-	(Mobile) LED Electronic Blackboard 1,663(W)x985(H)x103(D) or Mobile Screen(100") + Mobile Projector 5,000	-	-	On request		
210B	4.7x6.8x2.9	14	25	10	10	-	-	-	-		-	-			
210	9.4x6.8x2.9	32	55	20	20	-	-	-	-		-	-			
211	4.4x6.8x2.9	18	30	10	10	-	-	-	-		-	-			
211	4.4x6.8x2.9	18	30	10	10	-	-	-	-		-	-			
3F Auditorium & Meeting Rooms	Auditorium	37x31	2,104	(Fixed Type) TH 1,080			20x1.5	1.5x11	In front of the screen	Cable tie	20x7	Importing	24x11.5x1	4	1 A
	Lobby						15x1								
	R1	7.4x18x5.6	144	72	140	60	7.4x18x5.6	Negotiable	Negotiable	Negotiable	Mobile(100")	Mobile5,000	-	1	1 C
	R2	7.4x18x5.6	144	72	140	60	7.4x18x5.6						-	1	
	R3	7.4x12.4x3.5	104	54	100	40	7.4x12.4x3.5						-	-	
R4	7.4x12.4x3.5	104	54	100	40	7.4x12.4x3.5	-						-		
3F Conference Room E (Hall E)	E1	9.7x18.7x3.6	182	81	160	80	6.8x1	1x2.8	Behind the screen	Tack/Cable tie	4.4x2.5(200")	8,000	Mobile stage (per 1 unit 2.4x1.2x0.4)	2	2 small
	E2	8.9x16.7x3.6	149	72	140	70	6.8x1	1x2.8	Behind the screen	Tack/Cable tie	4.4x2.5(200")			2	2 small
	E3	8.9x16.7x3.6	134	72	140	70	6.8x1	1x2.8	Behind the screen	Tack/Cable tie	4.4x2.5(200")			2	2 small
	E4	8x18.7x3.6	152	81	160	70	6.5x1	1x2.8	Behind the screen	Tack/Cable tie	4.4x2.5(200")			2	2 small
	E1-E4	35.8x18.7x3.6	617	306	600	300	6.5x1/6.8x1	1x2.8	Behind the screen	Tack/Cable tie	4.4x2.5(200")			Negotiable	Negotiable
	E5	18.7x18.7x3.6	350	162	320	160	6.8x1(right)/4x1(left)	1x2.8	Behind the screen	Tack/Cable tie	4.4x2.5(200")			2	2 small
	E6	18.7x17x3.6	318	162	320	160	6.8x1/6.8x1	1x2.8/1x2.8	Behind the screen	Tack/Cable tie	4.4x2.5(200")			2	2 small
	E5-E6	18.7x35.8x3.6	668	324	640	300	Negotiable	1x2.8/1x2.8	Behind the screen	Tack/Cable tie	4.4x2.5(200")			Negotiable	2 small
	E1-E6	44.8x35.8x3.6	1,604	810	1,500	600	Negotiable	1x2.8	Behind the screen	Tack/Cable tie	4.4x2.5(200")			Negotiable	Negotiable
	E7	9.1x14.7x3.5	134	72	140	60	6.8x1	1x2.8	Behind the screen	Tack/Cable tie	4.4x2.5(200")			5,000	-
E8	5.1x8.9x3.3	46	24	40	20	4.5x1	1x2.6	Behind the screen	Tack/Cable tie	2.4x1.8(120")	Mobile 5,000	-	-	On request	

Venue	Dimensions W x L x H (m)	Area(m ²)	Capacity			Banner			Beam Projector		Stage(m) (Width x Length x Height)	Etc				
			CL	TH	BQ	Horizontal banner(m) (Width x Length)	Vertical banner(m) (Width x Length)	Banner (batten) Location	Banner display method	Screen (m) (Width x Length)		Projector (Lumen)	Number of rentable wireless microphones	Type of podium		
3F Conference Room (South)	300	14x18x3.5	264	126	240	100	5.9x0.8	1x3.1	In front of the screen	Tack/Cable tie	4x3(200")	7,500	-	2	2 C	
	301A	7.3x12.7x3.3	104	54	100	50	6x0.8	1x2.7	In front of the screen	Tack/Cable tie	3x2.4(150")	Mobile 5,000	-	1	1 B	
	301B	12.7x9.7x3.3	103	48	100	30	5x0.8	1x2.7	In front of the screen	Tack/Cable tie	3x2.4(150")	6,200	8x3x0.2	1	1 B	
	301	12.7x17.9x3.3	207	99	200	80	5x0.8	1x2.7	In front of the screen	Tack/Cable tie	3x2.4(150")	6,200	-	2	2 B	
	302	3.8x9x3.1	40	20	36	20	3x0.7	1x2.5	In front of the screen	Magnet/Cable tie (requires ladder)	Mobile (100")	Mobile 5,000	-	-	On request	
	303	3.9x9.5x3.1	40	20	36	20	3x0.7	1x2.5	In front of the screen	Magnet/Cable tie (requires ladder)	Mobile (100")	Mobile 5,000	-	-		
	304	6.2x9x3.1	54	24	48	30	4x1	1x2.5	In front of the screen	Magnet/Cable tie (requires ladder)	2.4x1.8(120")	Mobile 5,000	-	-		
	305	6.2x9x3.1	54	24	48	30	4x1	1x2.5	In front of the screen	Magnet/Cable tie (requires ladder)	2.4x1.8(120")	Mobile 5,000	-	-		
	306	3.8x9x3.1	40	20	36	10	3x0.7	1x2.5	In front of the screen	Magnet/Cable tie (requires ladder)	Mobile (100")	Mobile 5,000	-	-		
	307A	8x12.9x3.3	104	54	100	50	6x0.8	1x2.7	In front of the screen	Tack/Cable tie	3x2.25(150")	Mobile 5,000	-	2		2 B
	307B	10x12.9x3.3	104	54	100	50	6x0.8	1x2.7	In front of the screen	Tack/Cable tie	3x2.25(150")	Mobile 5,000	-			
	307C	12.9x8.5x3.3	103	48	100	30	5x1	1x2.7	Behind the screen	Tack/Cable tie	3x2.25(150")	6,200	8x3x0.2			
	307	12.9x26.8x3.3	311	156	300	150	5x1	1x2.7	Behind the screen	Tack/Cable tie	3x2.4(150")	6,200	8x3x0.2	2	2 B	
	308A	8x12.9x3.3	104	54	100	50	6x0.8	1x2.7	In front of the screen	Tack/Cable tie	3x2.25(150")	Mobile 5,000	-			
	308B	10x12.9x3.3	104	54	100	50	6x0.8	1x2.7	In front of the screen	Tack/Cable tie	3x2.25(150")	Mobile 5,000	-			
	308C	12.9x8.5x3.3	103	48	100	30	5x1	1x2.7	Behind the screen	Tack/Cable tie	3x2.25(150")	6,200	8x3x0.2	2	2 B	
	308	12.9x26.8x3.3	311	156	300	150	5x1	1x2.7	Behind the screen	Tack/Cable tie	3x2.4(150")	6,200	8x3x0.2			
	309	3.9x9.5x3.1	40	20	36	20	3x0.7	1x2.5	In front of the screen	Magnet/Cable tie (requires ladder)	Mobile (100")	Mobile 5,000	-			-
	310	6.2x9x3.1	54	24	48	30	4x1	1x2.5	In front of the screen	Magnet/Cable tie (requires ladder)	2.4x1.8(120")	Mobile 5,000	-	-	On request	
	311	6.2x9x3.1	54	24	48	30	4x1	1x2.5	In front of the screen	Magnet/Cable tie (requires ladder)	2.4x1.8(120")	Mobile 5,000	-	-		
	312	3.8x9x3.1	40	20	36	20	3x0.7	1x2.5	In front of the screen	Magnet/Cable tie (requires ladder)	Mobile (100")	Mobile 5,000	-	-		
	313	3.9x9.5x3.1	40	20	36	20	3x0.7	1x2.5	In front of the screen	Magnet/Cable tie (requires ladder)	Mobile (100")	Mobile 5,000	-	-		
	314	6.2x9x3.1	54	24	48	30	4x1	1x2.5	In front of the screen	Magnet/Cable tie (requires ladder)	2.4x1.8(120")	Mobile 5,000	-	-		
	315	6.2x9x3.1	54	24	48	30	4x1	1x2.5	In front of the screen	Magnet/Cable tie (requires ladder)	2.4x1.8(120")	Mobile 5,000	-	-		
	316	3.8x9x3.1	40	20	36	20	3x0.7	1x2.5	In front of the screen	Magnet/Cable tie (requires ladder)	Mobile (100")	Mobile 5,000	-	-	2	2 B
	317A	8x12.9x3.3	104	54	100	50	5x0.8	1x2.7	In front of the screen	Tack/Cable tie	3x2.25(150")	Mobile 5,000	-			
	317B	10x12.9x3.3	104	54	100	50	5x0.8	1x2.7	In front of the screen	Tack/Cable tie	3x2.25(150")	Mobile 5,000	-			
	317C	12.9x8.5x3.3	103	48	100	30	5x1	1x2.7	Behind the screen	Tack/Cable tie	3x2.25(150")	6,200	8x3x0.2			
	317	12.9x26.8x3.3	311	156	300	150	5x1	1x2.7	Behind the screen	Tack/Cable tie	3x2.4(150")	6,200	8x3x0.2			
	318A	8x12.9x3.3	104	54	100	50	6x0.8	1x2.7	In front of the screen	Tack/Cable tie	3x2.25(150")	Mobile 5,000	-	2		
	318B	10x12.9x3.3	104	54	100	50	6x0.8	1x2.7	In front of the screen	Tack/Cable tie	3x2.25(150")	Mobile 5,000	-			
	318C	12.9x8.5x3.3	103	48	100	30	5x1	1x2.7	Behind the screen	Tack/Cable tie	3x2.25(150")	6,200	8x3x0.2			
	318	12.9x26.8x3.3	311	156	300	150	5x1	1x2.7	Behind the screen	Tack/Cable tie	3x2.4(150")	6,200	8x3x0.2	On request		
	319	3.9x9.5x3.1	40	20	36	20	3x0.7	1x2.5	In front of the screen	Magnet/Cable tie (requires ladder)	Mobile (100")	Mobile 5,000	-		-	
	320	6.2x9x3.1	54	24	48	30	4x1	1x2.5	In front of the screen	Magnet/Cable tie (requires ladder)	2.4x1.8(120")	Mobile 5,000	-		-	
	321	6.2x9x3.1	54	24	48	30	4x1	1x2.5	In front of the screen	Magnet/Cable tie (requires ladder)	2.4x1.8(120")	Mobile 5,000	-		-	
322	3.8x9x3.1	40	20	36	20	3x0.7	1x2.5	In front of the screen	Magnet/Cable tie (requires ladder)	Mobile (100")	Mobile 5,000	-	-			
323	3.9x9.5x3.1	40	20	36	20	3x0.7	1x2.5	In front of the screen	Magnet/Cable tie (requires ladder)	Mobile (100")	Mobile 5,000	-	-			
324	6.2x9x3.1	54	24	48	30	4x1	1x2.5	In front of the screen	Magnet/Cable tie (requires ladder)	2.4x1.8(120")	Mobile 5,000	-	-	2	2 B	
325	6.2x9x3.1	54	24	48	30	4x1	1x2.5	In front of the screen	Magnet/Cable tie (requires ladder)	2.4x1.8(120")	Mobile 5,000	-	-			
326	3.8x9x3.1	40	20	36	20	3x0.7	1x2.5	In front of the screen	Magnet/Cable tie (requires ladder)	Mobile (100")	Mobile 5,000	-	-			
327A	8x12.9x3.3	104	54	100	50	6x0.8	1x2.7	In front of the screen	Tack/Cable tie	3x2.25(150")	Mobile 5,000	-				
327B	10x12.9x3.3	104	54	100	50	6x0.8	1x2.7	In front of the screen	Tack/Cable tie	3x2.25(150")	Mobile 5,000	-				
327C	12.9x8.5x3.3	103	48	100	30	5x1	1x2.7	Behind the screen	Tack/Cable tie	3x2.25(150")	6,200	8x3x0.2				
327	12.9x26.8x3.3	311	156	300	150	5x1	1x2.7	Behind the screen	Tack/Cable tie	3x2.25(150")	6,200	8x3x0.2	2	1 C		
328	6.6x13.9x2.9	96	48	100	40	5x1	1x2.2	Behind the screen	Cable tie	3x2.25(150")	5,000	-			2	
4F Conference Room (South)	400	5.6x13.8x3.4	78	(Fixed Type) BD 22			-	-	-	-	3.3x1.85(150")	5,000	-	2	1 B	
	401	16x34x7	489	(Fixed Type) TH 441			12x1.5	1.5x5	In front of the screen	Magnet/Cable tie	7.6x4.3(350")	10,000	13x9.4x0.8	4	2 A / 2 C	
	402	16.9x16.5x3.4	324	168	312	160	6.9x1	1x3	Behind the screen	Fixing clip/Cable tie	3.5x2.6(170")	6,200	11x3x0.2	2	2 C	
	403	8x16x3.2	144	72	144	60	6x1	1x3	Behind the screen	Tack/Cable tie	3x2.25(150")	5,000	6x2.5x0.2	2	2 C	
Grand Total			11,917	4,493	9,983	4,230										

EXHIBITION HALLS

Room	Dimensions		Ceiling Height		Usable Area		Capacities			
	Meters	Feet	Meters	Feet	Sq.Meters	Sq.Ft	CL	TH	BQ	
Hall A	A1	36.0 x 72.0	118.1 x 236.2	8.0/9.0	26.3/29.5	2,592	27,900			
	A2	36.0 x 72.0	118.1 x 236.2	8.0/9.0	26.3/29.5	2,592	27,900			
	A3	36.0 x 72.0	118.1 x 236.2	8.0/9.0	26.3/29.5	2,592	27,900			
	A4	36.0 x 72.0	118.1 x 236.2	8.0/9.0	26.3/29.5	2,592	27,900			
	A1+A2+A3+A4	144.0 x 72.0	472.4 x 236.2	-	-	10,368	111,600			
Hall B	B1	45.0 x 81.0	147.6 x 265.7	9.5	31.2	3,645	39,235			
	B2	45.0 x 81.0	147.6 x 265.7	9.5	31.2	3,645	39,235			
	B1+B2	90.0 x 81.0	295.3 x 265.7	9.5	31.2	7,290	78,470			
	swing space	18.0 x 40.0	59.1 x 131.2	6.2	20.3	720	7,750			
Hall C	C1	36.0 x 72.0	118.1 x 236.2	8	26.3	2,572	27,900			
	C2	36.0 x 72.0	118.1 x 236.2	12.3	40.4	2,592	27,900			
	C3	36.0 x 72.0	118.1 x 236.2	12.3	40.4	2,592	27,900			
	C4	36.0 x 72.0	118.1 x 236.2	8	26.3	2,592	27,900			
	C1+C2+C3+C4	144.0 x 72.0	472.4 x 236.2	-	-	10,348	111,600			
Hall D	D1	36.0 x 81.0	118.1 x 265.7	17.5	57.4	2,916	31,388	1,600	3,200	1,600
	D2	45.0 x 81.0	147.6 x 265.7	17.5	57.4	3,645	39,235	1,900	3,800	1,900
	D1+D2	81.0 x 81.0	265.7 x 265.7	17.5	57.4	6,561	70,623	3,500	7,000	3,500
	swing space	18.0 x 40.0	59.1 x 131.2	9.3	30.5	720	7,750			



Coex CLIENT MANUAL

Telephone +82 2 6000 1122, 1123

Facsimile +82 2 6944 8374

Email sales@coex.co.kr

Website www.coexcenter.com

Address 513, Yeongdong-daero, Gangnam-gu, Seoul, 06164, Korea

Published : 2019, November

coex